



**HEUFT PRODUCTS**  
for the food industry

---

YOUR PRODUCT.  
TRUE INSPECTION.  
SAFEGUARDING  
PERFECT QUALITY.

---

---

## HEUFT IS SYSTEMTECHNIK

---

Quality, safety and efficiency: this is what matters when filling and packaging food, drinks and pharmaceuticals! The modular solutions from HEUFT SYSTEMTECHNIK GMBH put these key factors into practice simply and effectively. They ensure, during maximum productivity, that only perfect products reach the market.



Glass splinter  
HEUFT InLine<sup>II</sup> series  
» page 10

Crack  
HEUFT InLine<sup>II</sup> series  
» page 10

Deformed flanged edge  
HEUFT FinalView<sup>II</sup> CAP  
» page 42

Leak  
HEUFT squeezer<sup>II</sup> series  
» page 34

Microleak  
HEUFT squeezer<sup>II</sup> series  
» page 34

Aluminium foil  
HEUFT GY  
» page 66

Stone  
HEUFT eXaminer<sup>II</sup> XB  
» page 32

Dented flanged edge  
HEUFT FinalView<sup>II</sup> CAP  
» page 42

Metal wire  
HEUFT eXaminer<sup>II</sup> XT  
» page 31

Offset at the overlap  
HEUFT FinalView<sup>II</sup> FO6  
» page 43

Leak  
HEUFT squeezer<sup>II</sup> series  
» page 34

Microleak  
HEUFT squeezer<sup>II</sup> series  
» page 34

Screw  
HEUFT eXaminer<sup>II</sup> XB  
» page 32

Labelling  
HEUFT TORNADO<sup>II</sup> series  
» page 46

Metal wire  
HEUFT eXaminer<sup>II</sup> XB  
» page 32

Metal fragment  
HEUFT eXaminer<sup>II</sup> XS  
» page 29

Leak  
HEUFT squeezer<sup>II</sup> series  
» page 34

Screw  
HEUFT eXaminer<sup>II</sup> XB  
» page 32

Stone  
HEUFT eXaminer<sup>II</sup> XB  
» page 32

Metal wire  
HEUFT eXaminer<sup>II</sup> XB  
» page 32

Metal fragment  
HEUFT eXaminer<sup>II</sup> XS  
» page 29

Leak  
HEUFT squeezer<sup>II</sup> series  
» page 34

Screw  
HEUFT eXaminer<sup>II</sup> XB  
» page 32

Stone  
HEUFT eXaminer<sup>II</sup> XB  
» page 32

Teflon splinter  
HEUFT eXaminer<sup>II</sup> XB  
» page 32

Metal wire  
HEUFT eXaminer<sup>II</sup> XB  
» page 32

Underfilled  
HEUFT SPECTRUM<sup>II</sup> VX  
» page 22

Tom label  
HEUFT FinalView<sup>II</sup> FO6  
» page 40

Ceramic splinter  
HEUFT eXaminer<sup>II</sup> XB  
» page 32

Metal wire  
HEUFT eXaminer<sup>II</sup> XB  
» page 32

Underfilled  
HEUFT SPECTRUM<sup>II</sup> VX  
» page 22

Plastic  
HEUFT eXaminer<sup>II</sup> XB  
» page 32

Incorrectly positioned label  
HEUFT FinalView<sup>II</sup> FO6  
» page 40

Torn label  
HEUFT FinalView<sup>II</sup> FO6  
» page 40

Closure safety  
HEUFT FinalView<sup>II</sup> CAP  
» page 42

Shotgun pellet  
HEUFT eXaminer<sup>II</sup> XB  
» page 32

Finish chip  
HEUFT InLine<sup>II</sup> series  
» page 10

Wire clip  
HEUFT eXaminer<sup>II</sup> XB  
» page 32

Overfilled  
HEUFT SPECTRUM<sup>II</sup> VX  
» page 22

Underfilled  
HEUFT SPECTRUM<sup>II</sup> VX  
» page 22

Metal fragment  
HEUFT eXaminer<sup>II</sup> XB  
» page 32

Closure defect  
HEUFT squeezer<sup>II</sup> series  
» page 34

Glass splinter  
HEUFT InLine<sup>II</sup> series  
» page 10

Glass splinter  
HEUFT eXaminer<sup>II</sup> XAC  
» page 28

Missing closure  
HEUFT SPECTRUM<sup>II</sup> VX  
» page 22

Underfilled  
HEUFT SPECTRUM<sup>II</sup> VX  
» page 22

Missing label  
HEUFT SPECTRUM<sup>II</sup> VX  
» page 22

Missing labels  
HEUFT SPECTRUM<sup>II</sup> VX  
» page 22

Thread defect  
HEUFT FinalView<sup>II</sup> CAP  
» page 42

Product defect  
HEUFT eXaminer<sup>II</sup> XB  
» page 32

Missing closure  
HEUFT SPECTRUM<sup>II</sup> VX  
» page 22

Underfilled  
HEUFT SPECTRUM<sup>II</sup> VX  
» page 22

Labelling  
HEUFT TORNADO<sup>II</sup> series  
» page 46

Canted closure  
HEUFT FinalView<sup>II</sup> CAP  
» page 42

Product defect  
HEUFT eXaminer<sup>II</sup> XB  
» page 32

Missing label  
HEUFT SPECTRUM<sup>II</sup> VX  
» page 22

Missing labels  
HEUFT SPECTRUM<sup>II</sup> VX  
» page 22

Labelling  
HEUFT TORNADO<sup>II</sup> series  
» page 46

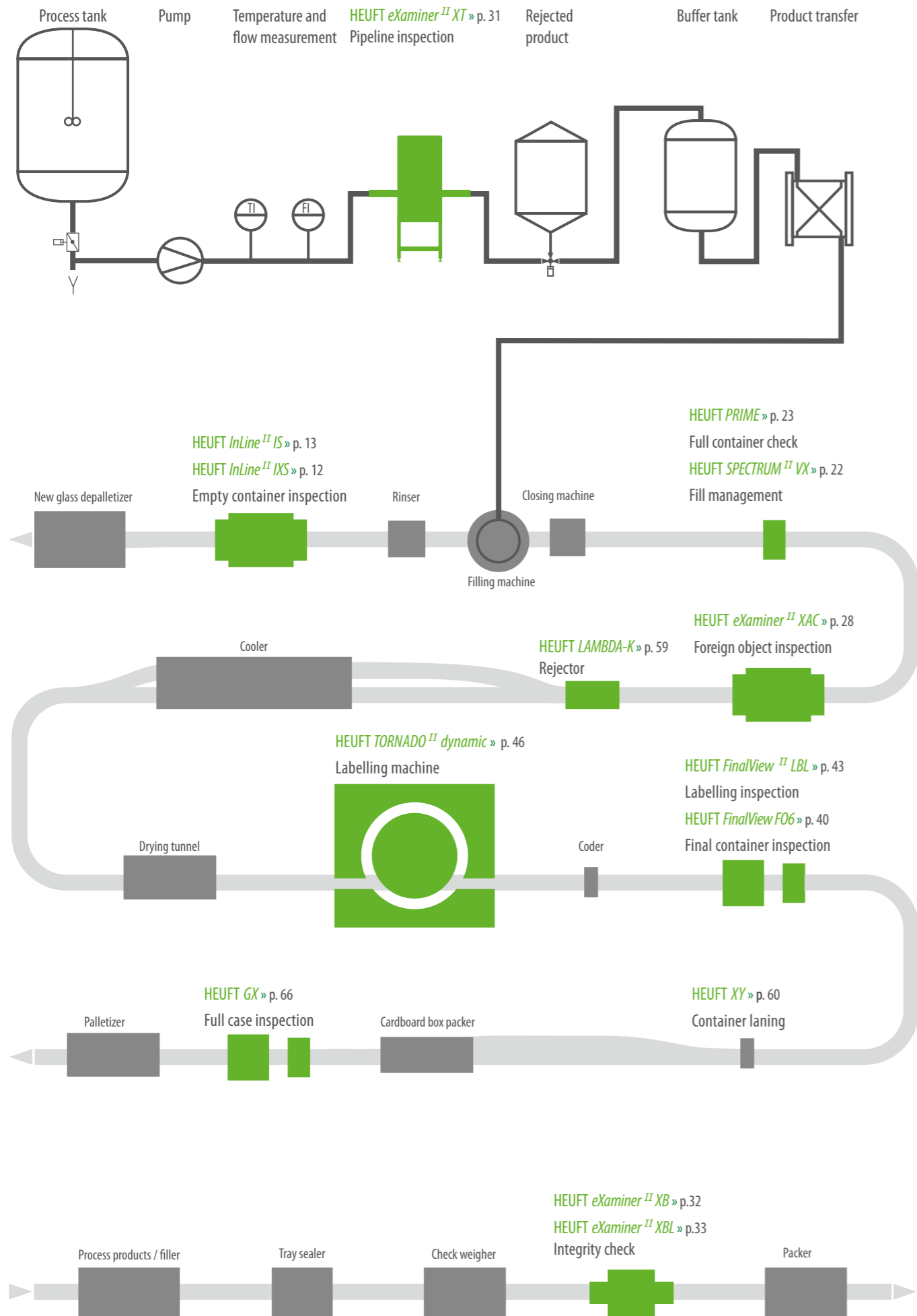

## PERFECT QUALITY FROM THE BEGINNING TO THE END

### EMPTY CONTAINER INSPECTION

HEUFT *InLine II IS* p. 12  
 HEUFT *InLine II IXS* p. 13  
 HEUFT *canLine* p. 15

### FULL CONTAINER CHECK & FILL MANAGEMENT

HEUFT *SPECTRUM II VX* p. 22  
 HEUFT *PRIME* p. 23  
 HEUFT *ONE* p. 25

### FOREIGN OBJECT INSPECTION

HEUFT *eXaminer II XAC* p. 28  
 HEUFT *eXaminer II XS* p. 29  
 HEUFT *eXaminer II XT* p. 31  
 HEUFT *eXaminer II XB* p. 32  
 HEUFT *eXaminer II XBL* p. 33

### LEAKAGE CHECK

HEUFT *squeezer II QS* p. 34  
 HEUFT *squeezer QL* p. 36

### FINAL CONTAINER INSPECTION

HEUFT *FinalView FO6* p. 40  
 HEUFT *FinalView II CAP* p. 42  
 HEUFT *FinalView II LBL* p. 43

### LABELLING

HEUFT *TORNADO II dynamic* p. 48  
 HEUFT *TORNADO II classic* p. 49  
 HEUFT *TORNADO* labelling units p. 51

### CONTAINER TRANSPORT

HEUFT *conveyor* & HEUFT *beetec* p. 56  
 HEUFT *synchron TXI* p. 57

HEUFT *LAMBDA-K* p. 59

### FAULT REJECTION

HEUFT *XY*, HEUFT *pusher*, HEUFT *mono*, HEUFT *e-Mono* p. 60  
 HEUFT *flip*, HEUFT *DELTA-FW*, HEUFT *DELTA-K* p. 61

### FULL CASE INSPECTION

HEUFT *GX* p. 66  
 HEUFT *logic* p. 67

### CASE REJECTION

HEUFT *xcase*, HEUFT *xtray* p. 68  
 HEUFT *maxi-flip*, HEUFT *maxi-laner* p. 69

### PDA & LINE ANALYSIS

HEUFT *PROFILER* family p. 72  
 HEUFT *RECIPER* p. 74  
 HEUFT *picCollect* p. 75

### COMPANY

Life Cycle Partnership p. 76

### 24 / 7 SERVICE

GLOBAL PLAYER / GLOBAL SERVICE p. 78

HEUFT *TeleService* p. 80

HEUFT *DeviceSupport* p. 81

HEUFT *PhoneService* p. 81

HEUFT *DirectService* p. 81

### COMPANY

SHOWROOM p. 82

TRAINING p. 82

SERVICE p. 83

CONFERENCES p. 83

TECHNOLOGICAL MILESTONES p. 84



---

## ERROR-FREE & SAFE

Checking, inspecting and protecting – already safeguarding the quality of food jars and cans before the filling process.

---

# Our devices for an empty container inspection

From empty can to X-ray empty jar inspection.



## Out with faulty primary packaging material. In with safety and quality.

Whether wide neck jar, smoothie bottle or food can: perfect empty containers are essential in order to keep the quality and product safety of food at the highest level. Compact HEUFT systems make sure that only perfect primary packaging is filled. The continuous complete inspection of each individual empty container using different detection technologies uncovers safety and quality defects reliably. The respective empty packaging is rejected consistently.

### Effective protection against product recalls and liability cases

Reliable detection and targeted rejection of faulty empty containers before the filling process.

### Maximum detection accuracy with a minimum false rejection rate

Precise identification of foreign objects, contamination, inclusions, cracks and defects. Clear differentiation between critical faults and harmless deviations for maximum line efficiency.

### No blind spots

Continuous base, sidewall, finish and thread inspection.

### Superior technologies

Unique optical and radiometric procedures for the reliable detection of a variety of faults.



**SIMPLY FINDING RELIABLY:**  
finish faults, chips, shell-shaped fractures and many other safety and quality defects.



## HEUFT *InLine II IXS*

Empty container inspection redefined: unique X-ray strobes for unparalleled detection reliability.



### From base to finish

Continuous optical complete inspection of each individual empty container without blind spots – powerful finish inspection especially for wide neck jars.

### Unparalleled detection reliability

Precise glass in glass detection and reliable identification of minute defects due to additional base inspection with unique pulsed X-ray technology.

### Simply easy

Maximum automation and self-explanatory audiovisual user guidance.

### Smart and capable of learning

Sustainable teach-in of individual quality requirements.

## HEUFT *InLine II IS*

The new standard for a superior empty container inspection on a HEUFT level.



### Premium becomes standard!

Specific combination of trendsetting technologies from the premium empty container inspection of the new generation with a completely new, compact, hygiene-optimised and easy to maintain construction.

### Comprehensive detection

Complete examination of all the areas of each food jar and bottle with real-time image analysis capable of learning for the identification of all risks and defects. Fourfold sidewall inspection for more than 360° coverage with double resolution.

### Superior construction

Open, easily accessible HEUFT *CleanDesign* with neither frame nor machine table for minimum cleaning and uncomplicated maintenance. Even more compact than its predecessor despite the full integration of all the detection modules including residual lye detection.

### Maximum automation and full operating reliability

Optimised container transport and fine alignment, automatic adjustment of all transport and detection units during brand changes. Highly automated HEUFT *SPECTRUM II* platform with audiovisual HEUFT *NaVi* user guidance.



Discover more

up to  
**1,400**  
containers per minute

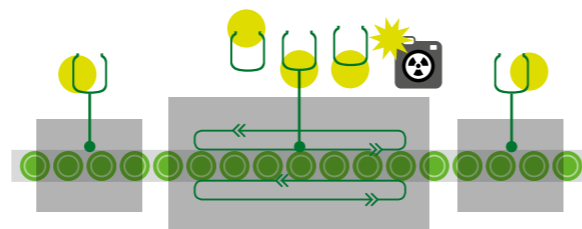
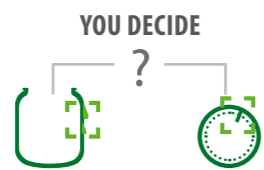

180° -  
usable on both sides

integrated residual lye detection

extremely easy to maintain



4 x SW / 2 x resolution

space-saving construction

hygienic design without table

up to  
**1,400**  
containers per minute



Discover more



HEUFT *reflex* | HEUFT *reflex*<sup>2</sup> real-time image processing  
**DETECTION ACCURACY UP AND FALSE REJECTION RATE DOWN!**

Even the best detection technologies are useless if the image processing system cannot keep pace. That is why we developed our own as early as 2002 - with in-house developed hardware and software optimally tailored to food inspection tasks:

**the HEUFT *reflex* safeguards product quality and output.**

Because the image processing system with multi-processing capabilities carries out a specific object detection. It combines several photographs in real time into extremely clear, continuous detection pictures for this and evaluates them directly. Faults are reliably detected even during high-speed operation and clearly distinguished from harmless deviations: only rejecting that which really has to go.

What this is exactly lies in your hands with the new generation of image processing. In addition to the specific detection of the most varied objects the HEUFT *reflex*<sup>2</sup> also carries out their individual classification: you can select them using the touchscreen and characterise them yourself as either good or unwanted.

**The HEUFT *reflex*<sup>2</sup> remembers your quality requirements.**

This teach-in together with a faster image transmission and more computing power, resolution, colour depth and contrast increases the detection accuracy yet again. The false rejection rate is reduced substantially. Therefore at maximum productivity only those products reach the customer which fulfil your individual quality criteria exactly.

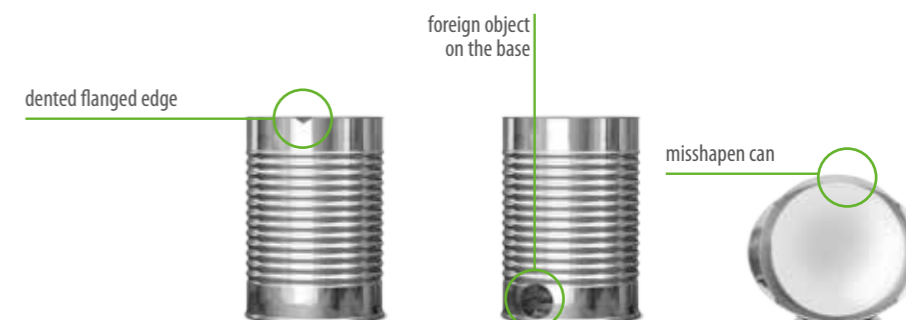

**HEUFT *canLine***

Empty can inspection for increased product safety and productivity.



**Maximum productivity**

Effective protection against obstructions when filling and sealing food cans.

**Maximum product safety**

Reliable detection of contamination and soiling inside the can.

**Top performance due to depth of field**

Precise identification of indentations and defects at the flanged edge, contaminants on the inner wall, foreign objects on the base and distorted containers with only one single camera.

**Changing simply**

Fast brand and format changes at the touch of a button.

ENLIGHTENMENT

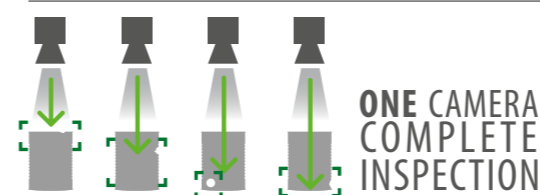





Inspecting empty and full containers automatically



Changing brands automatically and assisted



Detecting quality defects automatically



Rejecting faulty products automatically



Universal device platform

## CROSS-SYSTEM, HIGHLY AUTOMATED AND POWERFUL!

Its consistent modular design principle for a variety of technologies, modules, functions and applications makes HEUFT solutions stand out. A universal platform for individually equipped devices was created with the HEUFT *SPECTRUM TX* almost twenty years ago.

### The HEUFT *SPECTRUM II* goes one step further!

The new generation control unit capable of multiprocessing is just as impressive as its predecessor with a cross-system component equality of 70%, a correspondingly high spare parts availability and a future-proof network connection. In addition it saves valuable human resources due to an exceptional degree of automation and a self-explanatory human machine interface with the audiovisual HEUFT *NaVi* user guidance.

The latest in-house developed hardware and software for significantly more computing power and for real-time data transmission quadruples the precision during purposeful product tracking:

**the actual position of each individual container can be accurately determined up to 0.5 millimetres.**

This ensures that each one is really inspected and each faulty one is removed reliably.



### SAFEGUARDING PRODUCT QUALITY? SIMPLY AUTOMATICALLY! SIMPLY EASY!

HEUFT *SPECTRUM II* systems work fully automatically most of the time. The rest is covered by the HEUFT *NaVi* – with individual support and audiovisual step by step assistance. This

- saves time and resources
- increases the detection reliability
- safeguards error-free operation time

during the in-line quality inspection of empty and full containers. SIMPLY EASY!





---

## CHECKED & PRECAUTIONS TAKEN

Checking, detecting and preventing – finding quality defects such as fill level deviations and closure faults reliably and exposing the causes in good time.

---

# Our devices for a full container inspection

From fill level detection to filler / closer management.



## Up with product quality. Up with productivity.

Maximum product quality and maximum filler and closer efficiency: checking devices and fill management systems from HEUFT ensure both. Proven functions for checking and inspecting full containers safeguard product quality. Serial fault detection and continuous monitoring uncover losses in the performance of the filling and closing machine before the efficiency and productivity of the complete filling line suffer.

### Highest product quality

Reliable identification and removal of underfilled and overfilled, unsealed and unlabelled containers.

### Highest productivity

Direct localisation of sources of interference and error for early preventive maintenance.

### Highest production quality

Continuous product tracking, reliable quantifying and targeted sampling.

### Highest availability

Reliable and easy to handle HEUFT systems.

**FULL QUALITY AND FULL PRODUCTIVITY:**  
finding fill level and closure faults reliably and locating their causes in good time.



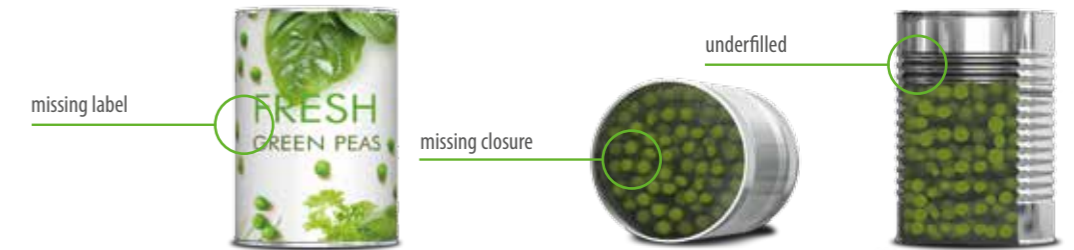

## HEUFT SPECTRUM II VX

Fill management based on the HEUFT SPECTRUM II.

### Optimal product quality

Reliable detection of underfills and overfills, closure and label faults.

### Preventive maintenance for maximum productivity

Early detection of losses in performance and sources of error due to consistent monitoring of the filler valves and closer heads.

### Evaluation and distribution

Fill value statistics, sampling and container distribution onto up to seven lanes.

### Superior operational reliability

Highly automated HEUFT SPECTRUM II system with self-explanatory HEUFT NaVi user guidance.



## HEUFT PRIME

Full container check of the new generation.

### Compact quality check

Reliable detection of underfilled / overfilled, unsealed and unlabelled food containers.

### Increased line efficiency

Serial fault detection and early localisation of faulty filler valves.

### No recalls

Reliable rejection of full containers with quality defects.

### Easy operation

Automatic brand changes and extensive audiovisual step-by-step assistance.



Discover more

up to  
**1,650**  
containers per minute



up to  
**1,200**  
containers per minute



Discover more



Locator, quantifying and fill management  
**HIGH PRODUCT QUALITY AND HIGH OUTPUT!**

It is good to find fill level and closure faults whilst still on the food line. This offers protection against complaints and expensive product recalls. However it is even better to expose the causes of such quality defects at an early stage.

**This prevents serial faults, line stoppages and expensive productivity losses.**

You can manage both with HEUFT! The devices for a full container check already have a locator function. It allocates detected faults to the corresponding filler valves and closer heads. A switch-off pulse is emitted when their number exceeds an individually definable threshold value. Therefore malfunctions can be eliminated in good time.

Fill management systems such as the HEUFT *SPECTRUM* <sup>II</sup> *VX* even go one step further - with an extensive filler and closer management: all the filler valves and closer heads are monitored continuously.

**Therefore the causes of deviations in filling quantities and closure faults are obvious long before they fail completely.**

This gives you time for preventive maintenance before high false rejection rates and production downtimes occur.

ENLIGHTENMENT



# HEUFT ONE

Your entry to a compact full container check on a HEUFT level.

**ONE for all!**

A completely new category of slimline devices for an affordable introduction to a reliable full container check.

**Full quality check**

Precise code verification or fill level detection for full containers. Smart sensor technology for examining the presence and position of the closure.

**Space-saving construction and easy handling**

Easy to integrate stand-alone system. Flexibly combinable detections directly on the conveyor connected to a compact control unit designed for optimum hygiene. Easy brand changes. Clear display with the HEUFT *NaVi* user interface for straightforward operation.

**Real cutting-edge technology on a HEUFT level**

Affordable complete solution comprising innovative detection technologies, in-house developed hardware and software and proven procedures for highly precise product tracking, inspection and fault rejection. Additional detection modules can be connected e.g. code verification.

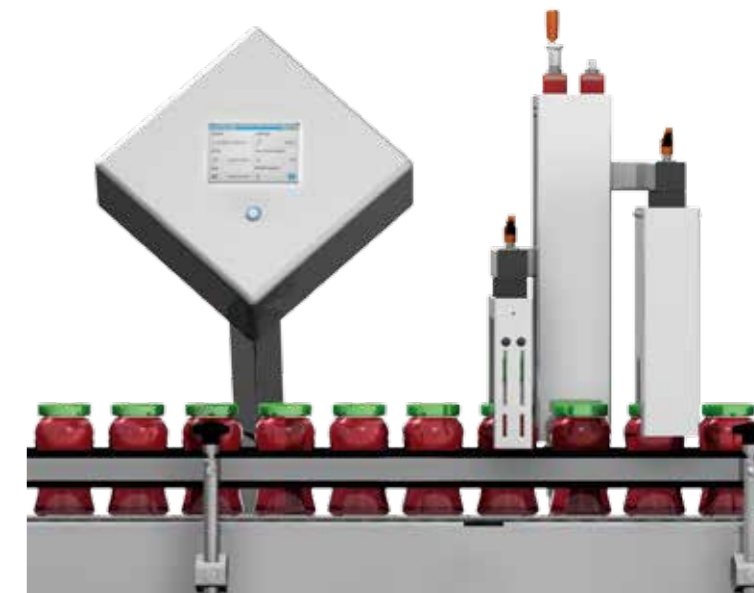

**up to 1,200**  
containers per minute



Discover more

# Our devices for a foreign object detection

From metal detection to glass in glass detection.



## Contamination inside. Product out.

Glass splinters, small pieces of metal and stones: contamination with foreign objects is one of the most frequent causes of product recalls. It poses a serious health hazard to the consumer. You can eliminate this with HEUFT. Contaminated products and packaging are identified reliably whilst still on the line. Our unique pulsed X-ray technology achieves this with unrivalled care and precision. Even faults barely noticeable with the naked eye hidden behind product and packaging structures cannot escape the inspection. This creates maximum product safety.

### Safe products

Precise identification of foreign objects which are hazardous to health.

### Protection against product recalls

Timely rejection of contaminated products.

### Smart demarcation

Lowest false rejection rate due to a clear distinction between real and supposed faults.

### Full transparency

Unique X-ray strobes for the reliable identification of dangerous foreign objects with minimum radiation.

**MAKING THE INVISIBLE VISIBLE:**  
identifying dangerous foreign objects simply reliably.



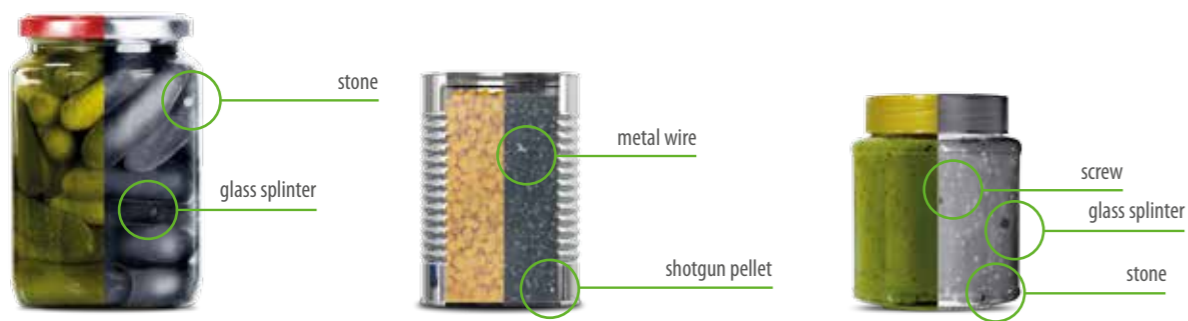

## HEUFT eXaminer<sup>II</sup> XAC

Full container inspection with pulsed X-ray technology based on the HEUFT SPECTRUM<sup>II</sup>.

### Prevention of product recalls and liability cases

Continuous complete inspection of the total container volume for a reliable in-line identification of dangerous foreign objects such as metal fragments or glass splinters.

### Maximum detection reliability

Sharp, high-resolution X-ray images with minimum radiation.

### A hundred per cent examination of large size containers

Full coverage due to particularly large sensitive detection surface.

### Self-explanatory and simply easy

Error-free operation due to maximally automated HEUFT SPECTRUM<sup>II</sup> platform and self-explanatory audiovisual user guidance.



## HEUFT eXaminer<sup>II</sup> XS

Space-saving end of line X-ray system of the new generation for a full-covering sidewall inspection.

### Foreign object detection on a HEUFT level

Maximum food safety due to unique pulsed X-ray technology for a careful and precise identification of high-density foreign objects in freshly filled food cans, squeeze bottles, stand-up pouches and doypacks.

### Full coverage in a confined space

Optimally arranged X-ray strobes, safely enclosed in a particularly space-saving casing directly at the conveyor for full detection certainty without blind spots from the container base to the fill line.

### Fewer false rejections

Highly precise product tracking and the HEUFT reflexx<sup>2</sup> real-time image processing system with learning ability for the reliable differentiation between real and supposed safety risks.

### Full operational and manipulation reliability

Highly automated HEUFT SPECTRUM<sup>II</sup> system with self-explanatory HEUFT NaVi user guidance for a safe and error-free operation.



Discover more

up to  
**1,200**  
containers per minute

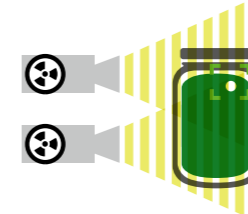
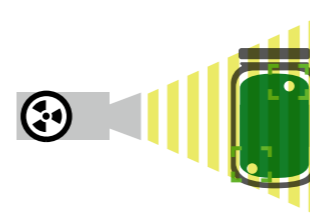
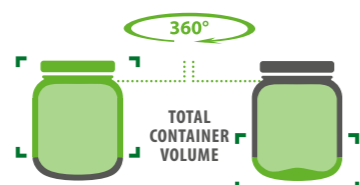

up to  
**1,200**  
containers per minute



Discover more



PULSED X-RAY TECHNOLOGY  
**MAXIMUM PRECISION  
 AND MINIMUM RADIATION!**

HEUFT X-ray systems identify foreign objects, product faults and packaging defects both precisely and carefully. In contrast to the conventional X-ray scanner their unique pulsed X-ray technology only emits radiation at the moment when a product to be examined is really in the inspection area. And that as an X-ray flash lasting just a thousandth of a second.

**The extremely short exposure time prevents motion blurs and reduces the reflected X-rays by a factor of 1,000.**

No product is exposed to a higher dose than is absolutely necessary. Thus an X-ray strobe only emits radiation for 36 seconds when inspecting 36,000 containers per hour. As a result there is no emission whatsoever during 99% of the time. By contrast, conventional X-ray scanners emit radiation continuously for 60 minutes. That alone makes the pulsed X-ray technology unique.

**Combined with innovative full-field image converters it achieves an unprecedented dimension in range, speed and detection accuracy.**

The size of the foreign objects which can be reliably identified has been halved!



**ENLIGHTENMENT**

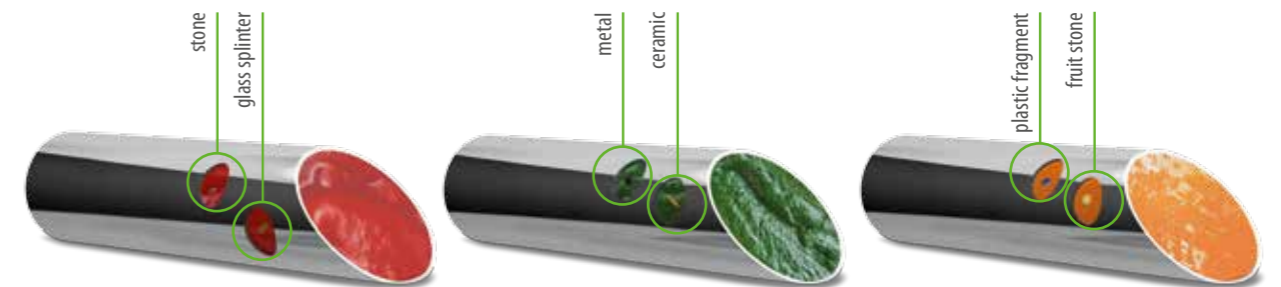

# HEUFT *eXaminer II XT*

Optimised pipeline inspection for the reliable detection of dangerous foreign objects in a liquid or paste-like product mass based on the HEUFT SPECTRUM II.

**Careful examination even before packaging**

Precise X-ray pipeline inspection of sauces, jams, cheese spreads, sausage meat and other unpackaged products.

**Reliable foreign object detection**

Unique X-ray strobes and innovative image converter technology for the careful, speed-independent identification of the smallest high density objects made of glass, stone, metal or plastic. Clear distinction between critical faults and harmless product structures. Optional integration of an additional X-ray strobe for a 3D reconfirmation of the result of the examination from another perspective.

**Simply even more precision**

Highly automated HEUFT SPECTRUM II platform with audiovisual HEUFT NaVi user guidance for considerably more precision when tracking products, detecting foreign objects and rejecting faults. Fully automatic product change without recalibration.

**Complete safety due to optimised design**

New compact, easily accessible construction with the hygiene and maintenance optimised HEUFT CleanDesign. Now also with a vertical pipeline and drain valve for an even more reliable rejection of the contaminated partial quantity.

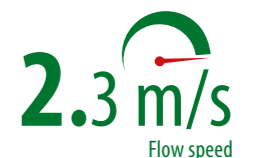
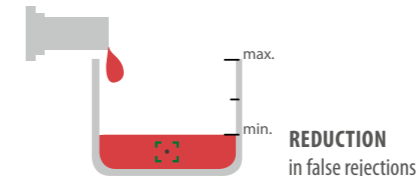
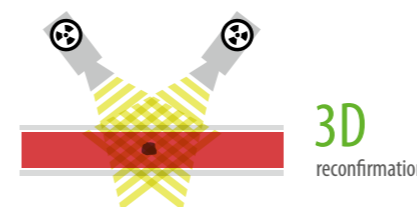



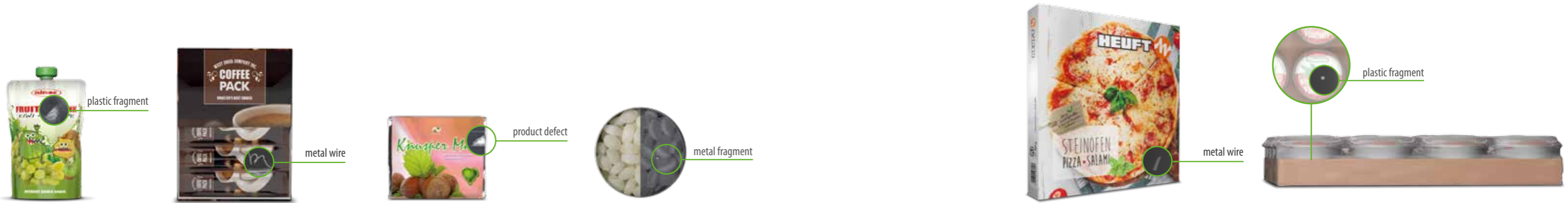

## HEUFT eXaminer<sup>II</sup> XB

Top-down inspection with pulsed X-ray technology based on the HEUFT SPECTRUM<sup>II</sup>.

### Effective injury and recall prevention

Reliable foreign object detection during the complete inspection of filled primary, secondary and tertiary packaging as well as solid products.

### Reliable integrity check

Certain detection of incomplete products and packaging as well as defects.

### Superior technologies and maximum automation

Optimised pulsed X-ray technology and maximum detection accuracy with minimum radiation. Highly automated HEUFT SPECTRUM<sup>II</sup> platform with self-explanatory user guidance.

### Flexible expansion for even more performance

Multi flash option for the complete inspection of even larger products. Division of the conveyor for the parallel inspection of two smaller products at the same time.



## HEUFT eXaminer<sup>II</sup> XBL

Even more coverage during the top-down inspection with pulsed X-ray technology based on the HEUFT SPECTRUM<sup>II</sup>.

### Effective injury and recall prevention

Reliable foreign object detection during the complete inspection of filled primary, secondary and tertiary packaging as well as solid products.

### Reliable integrity check

Certain detection of incomplete products and packaging as well as defects.

### Superior technologies and maximum automation

Optimised pulsed X-ray technology and maximum detection accuracy with minimum radiation. Innovative image converter technology for full coverage during the top-down inspection of even larger products such as frozen pizzas or complete yoghurt trays. Highly automated HEUFT SPECTRUM<sup>II</sup> platform with self-explanatory user guidance.

### Flexible expansion for even more performance

Multiple flash option for the complete inspection of particularly long products. Division of the conveyor for the parallel inspection of two smaller products at the same time.



Discover more

up to  
**1,200**  
containers per minute

IDEAL FOR  
LIGHT-  
WEIGHTS



contactless



LEAD SCREENS  
ARE NOT  
REQUIRED

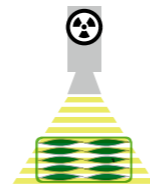

MODULE

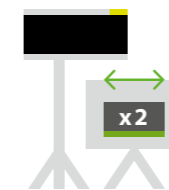

up to  
**1,200**  
containers per minute



Discover more

## Our devices for a leakage check

From internal container pressure measurement to the identification of microleaks.

### Leak identified. Danger eliminated.

Leaks, stress cracks and microcracks: such leaks have no place in freshly filled food containers made of plastics such as PET or HDPE. They not only threaten the integrity and stability of the packaging but also the microbial purity and therefore the edibility and shelf life of the product contained in it. You can expose leaking primary packaging material in-line and reject it reliably before it reaches the market and can pose a threat to the consumer with the leakage checks of the HEUFT *squeezer* series.

#### High packaging quality and high product safety

Sustainable safeguarding of the container stability and effective protection against microbially contaminated food.

#### Full shelf life for full enjoyment

Effective prevention of premature spoilage of the product.

#### Clean surroundings

No sticky contamination on the line, during transport or at the point of sale caused by an unwanted product leakage.

#### Maximum product quality

Correct nominal filling quantity and high closure integrity.



**NO LEAKS AND EVERYTHING SECURE:**  
uncovering leaks in good time.



## HEUFT squeezer II QS

Leakage check based on the HEUFT SPECTRUM II.

### Leakproof packaging and pure contents

Reliable detection of minute leaks in filled plastic containers for the sustainable safeguarding of packaging and product integrity.

### Full stability

Precise measurement of the internal pressure of the container for stable full containers which can be optimally transported and stored.

### Outstanding detection reliability

Comparative fill level detection in a non-compressed and compressed condition for maximum precision when identifying leaks.

### Reliable and easy operation

Maximally automated HEUFT SPECTRUM II system with self-explanatory audiovisual HEUFT NaVi user guidance.



## HEUFT squeezer QL

Leakage check for the clear identification of minute microleaks in plastic containers.

### Total food safety

Reliable identification of minute leaks due to internal container pressure measurement and comparative fill level detection.

### Maximum detection reliability

Extra long inspection path for an even more reliable identification of hardly visible leaks.

### Microbial purity

Specific rejection of leaking packaging with contents which could be germ-laden.

### Automatic brand changes

Servo-controlled adaptation of the transport and detection units at the touch of a button.



Discover more

up to  
**1,200**  
containers per minute

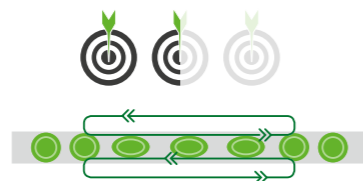

4x MODULES



MODULE

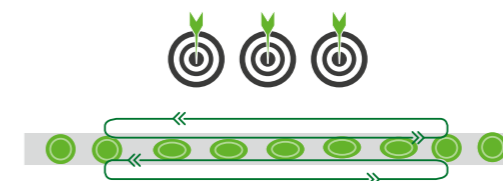

up to  
**1,200**  
containers per minute



Discover more

# Our devices for an outer appearance inspection

From label to closure inspection.



## Impeccably labelled. Securely sealed.

Baby food jars, snack packaging and ketchup bottles: an attractive presentation of the full food containers is what counts at the point of sale (POS) as well as their complete integrity. Missing, incorrect or non-brand labels and designs impair the appearance of the packaging and at the same time the safety of the end product. Closure defects threaten the microbial purity and the harmless consumption of sensitive food. You can find such faults before the customer does with the HEUFT *FinalView*<sup>II</sup> solutions for an extensive label, design and closure inspection.

### Attractive appearance

A thorough final inspection for flawless labels and an irresistible packaging design at the POS.

### Full closure safety

Careful complete inspection for the precise detection of missing, canted, non-brand as well as faulty closures and safety elements.

### High informational value

Complete all-around inspection for the timely identification of non-brand, incorrectly positioned or faulty labels and designs as well as the reading and verification of applied lettering and product coding.

### Flexible solutions for maximum product quality

From a fully equipped complete system to a compact stand-alone module at the conveyor: different versions for specific requirements.

**PERFECT DRESS:**  
examining labels, designs, markings and closures carefully.





## HEUFT *FinalView FO6*

Continuous final inspection of the dress of filled food containers.

### Flawless appearance at the POS

Highly precise identification of non-brand, incorrectly positioned, scratched, creased, misprinted and soiled labels.

### Clear marking

Detailed inspection of the packaging design and the lettering. BBD verification with automatic date adaptation and barcode reading.

### No blind spots

Continuous 360° inspection without reflections or shadows even when the containers are not aligned.

### Genuinely sealed

Examination of the presence, colour and logos of the closures.



- TX
- 
- reflexx<sup>2</sup>
- 
- 
- 360°



Discover more

up to  
**1,200**  
containers per minute

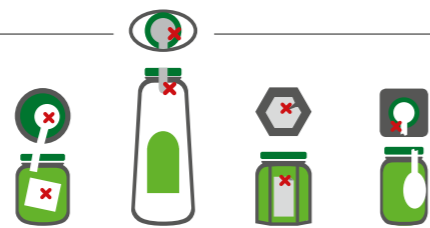

Illumination free of shadows and reflections



## Real-time product tracking and reject verification **PRECISE MONITORING FOR FULL DETECTION RELIABILITY**

Where is the product? You should know this. The exact current whereabouts of a particular container on the line must be known at all times. A reliable inspection and fault rejection is only then possible.

The distance covered and the position of each individual food package on the conveyor is triggered repeatedly and tracked precisely.

### **Precise real-time monitoring is the guarantee for full detection reliability.**

It locates the exact whereabouts of all the containers constantly with millimetre accuracy. This ensures that each individual one is really examined and each faulty one is actually removed.

### **Permanent product tracking guarantees maximum accuracy when rejecting faults.**

Only those jars, cans and food products which really have to go are removed. The monitoring procedure even goes a step further: the integrated reject verification records immediately if a fault which should be rejected has not left the line yet.

ENLIGHTENMENT

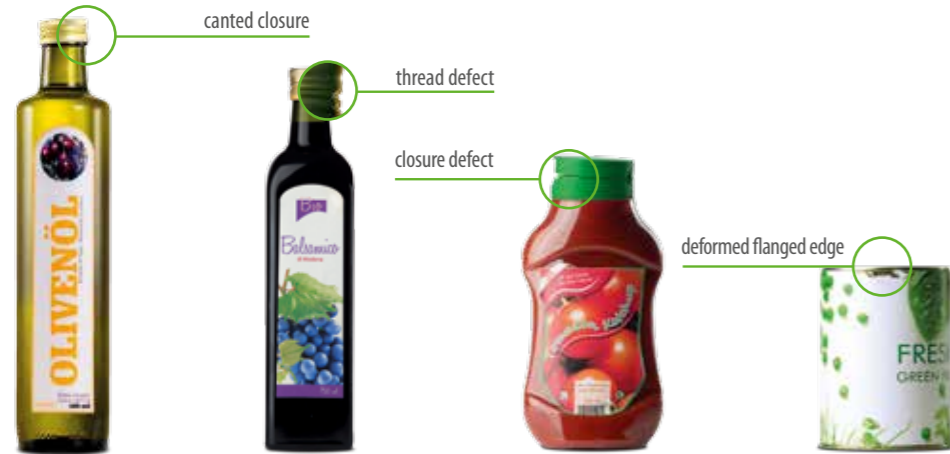

## HEUFT FinalView II CAP

Detailed closure inspection based on the HEUFT SPECTRUM II.

### Full closure safety and maximum product integrity

Continuous all-around inspection of container closures and their safety elements.

### Superior detection accuracy

Reliable identification of non-brand, canted, defective, leaking and incorrectly positioned closures. Clear detection of thread faults, faulty tamper evident opening tabs and damaged tamper evident and neck rings.

### Individual and flexible

Different detection modules for specific requirements from a presence check, colour logo inspection to closure alignment examination with millimetre precision.

### Highly automated and self-explanatory

Maximum automation and audiovisual step-by-step assistance for utmost operational reliability.

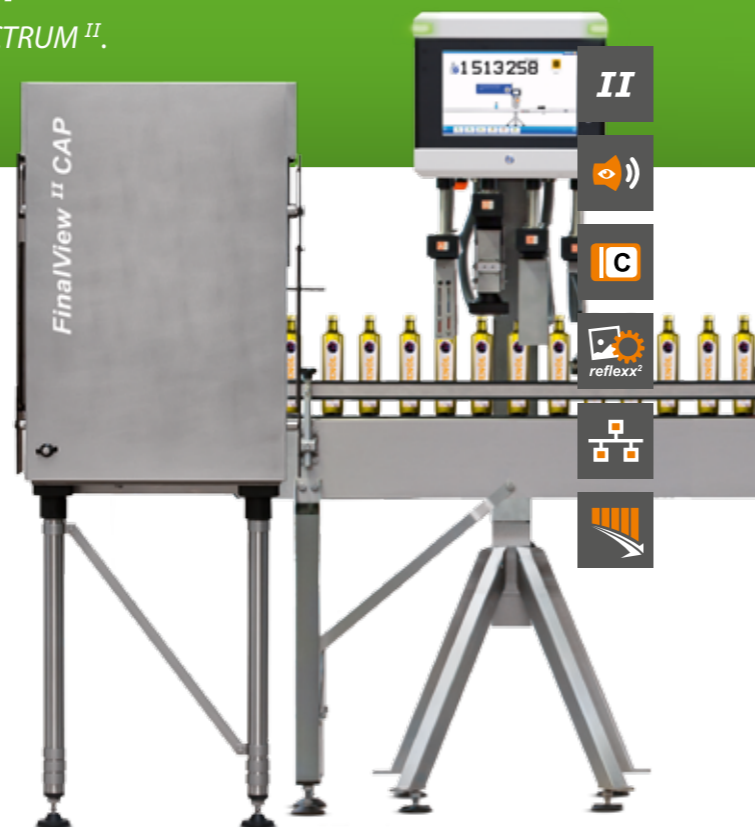

## HEUFT FinalView II LBL

Detailed label inspection based on the highly automated HEUFT SPECTRUM II for perfectly dressed end products.

### Faultless appearance

Gapless complete inspection of all the labels and design elements as well as the reliable identification and rejection of incorrectly dressed containers.

### Maximum detection reliability

Reliable detection of crooked, non-brand, creased and torn labels as well as the clear identification of design faults due to superior optical technologies and the HEUFT reflex<sup>2</sup> image processing system with teach-in assistant.

### Optimal adaptation

Adaptive LED illumination for detection pictures without shadows or reflections and optional add-on cameras for different container types and sizes.

### Full automation and maximum operational reliability

Highly automated, network-compatible HEUFT SPECTRUM II platform for simple brand changes with no manual effort and simply more performance during a precise container tracking, inspection and rejection. Audiovisual HEUFT NaVi user guidance for error-free, tamper resistant operation.

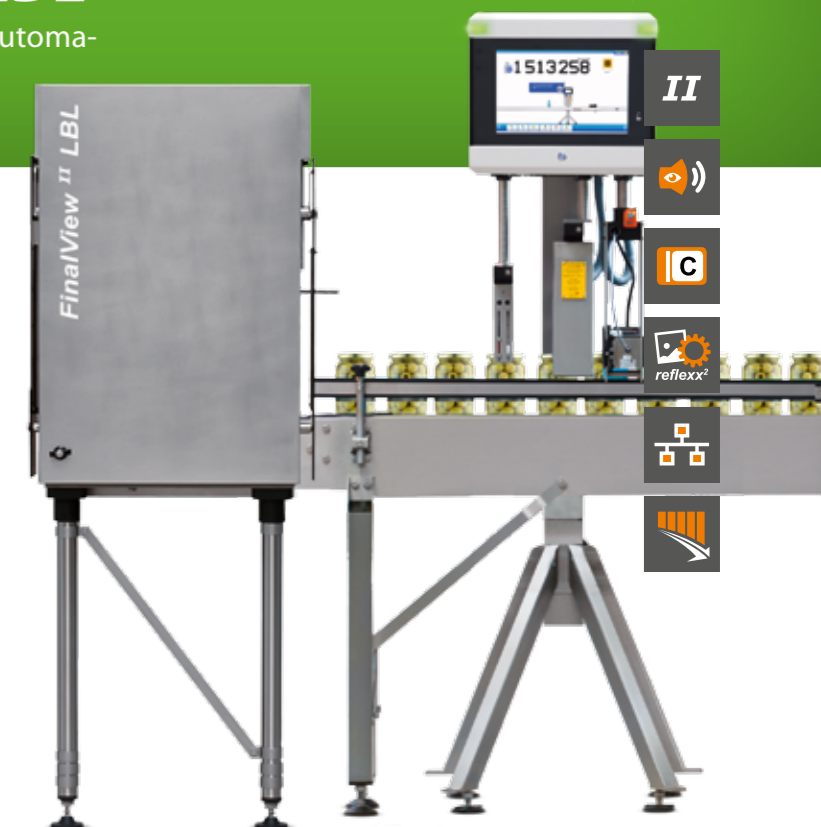

Discover more

up to  
**1,650**  
containers per minute

1.4x  
more performance

1.5x  
larger height  
difference

1.2x  
wider closure  
diameter

6x  
higher resolution



up to  
**1,200**  
containers per minute



Discover more



Station 2

# PERFECTLY DRESSED & TRULY ATTRACTIVE

Aligning, applying and attracting attention - labeling food containers accurately and tidily.

# Our new generation of labelling machines.

From wet glue to wrap-around labelling.



## Faultless dress. Optimum appearance.

Aligning, applying and standing out: the labelling machines of the HEUFT *TORNADO II* series make this possible! They carry out a clean and exact application of filled containers with attractive wet glue, hot glue, wrap-around and self-adhesive labels in the smallest of spaces with even more performance, dynamism and flexibility. The labellers based on the network compatible, highly automated HEUFT *SPECTRUM II* platform can be equipped with several different labelling stations flexibly, partly retrofitted especially quickly and easily and even operated by voice! In addition easy to integrate add-on modules check the quality of the newly labelled full container in the same process.

### Full information

Reliable, optimally readable information about the product inside due to brand consistent, error-free labelling.

### High-precision application

Extremely precise labelling without creases, bubbles or offset due to *flex* technology for an accurate servo-controlled fine alignment of the bottles and the new HEUFT *SPECTRUM II* performance.

### Perfect look

Attractive container dress for a high recognition value at the POS and sustainable brand protection.

### Versatile procedures

Accurate wet glue, hot glue, self-adhesive and wrap-around labelling of a wide range of container shapes and areas.

**TIDILY AND ACCURATELY LABELLED:**  
applying labels exactly and without faults.







## HEUFT TORNADO II dynamic

New generation of labelling machine without machine table which can be dynamically equipped and retrofitted (with integrated hands-free voice control).

### Simply more dynamism and flexibility

The first easily accessible HEUFT compact solution without machine table for easier and more flexible equipping and retrofitting with up to four wet glue, wrap-around and self-adhesive labelling stations as required.

### Accurate application and integrated quality inspection

Integrated detection modules for a camera-based, servo-controlled HEUFT TORNADO II flex fine alignment of the containers for particularly accurate labelling results as well as, among other things, a direct labelling, fill level and closure check, BBD and code verification.

### Uncomplicated brand and program changes

Replacement of change parts without tools, automatic adjustment of the machine head and detection modules as well as a rotating cam which can be programmed according to the brand. Easier integration of additional units and procedures for greater flexibility regarding container dress with different types of labels.

### Genuinely responsive performance

Highly automated HEUFT SPECTRUM II device platform for considerably more performance when tracking containers, labelling, identifying faults and rejecting. Audiovisual HEUFT NaVi user guidance and new dialogue function for voice control of the machine.



## HEUFT TORNADO II classic

Versatile labelling machine based on the HEUFT SPECTRUM II.

### Perfect dress

Accurate application of body, collar, back, neck ring and closure labels with up to three permanently mounted wet glue, self-adhesive or wrap-around labelling stations. Optionally with the HEUFT TORNADO II flex servo technology for a precise camera-based fine alignment of the containers for simply perfectly positioned labels.

### Integrated check

Examination of the label presence in the same process. Straightforward integration of further detection modules e.g. for a fill level, closure and marking check.

### Uncomplicated brand change

Replacement of change parts without tools, automatic adjustment of the machine head and detection modules as well as a rotating cam which can be programmed according to the brand and is reproducible at any time.

### Durable construction on a new platform

Low maintenance requirements due to the proven robust construction of the HEUFT CleanDesign. Highly automated HEUFT SPECTRUM II platform with the audiovisual HEUFT NaVi user guidance and optional hands-free voice control for simply more labelling performance and operational reliability.



Wet glue units not electrically but mechanically coupled for the parallel use of several stations in one machine.



up to  
**1,200**  
containers per minute

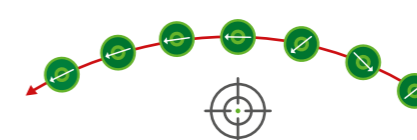
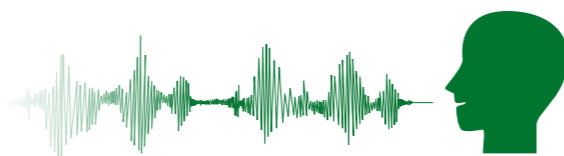
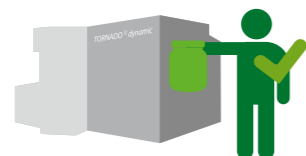

up to  
**1,200**  
containers per minute



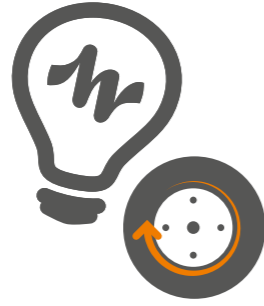

HEUFT *TORNADO flex* servo technology

## EXTREMELY EXACT AND EXTREMELY EFFICIENT!

First-class labelling results, particularly easy brand changes and considerably less wear and tear: servo labelling machines of the HEUFT *TORNADO flex* series achieve a maximum amount of precision, flexibility and profitability during the application of labels.

The servo technology carries out a fine container alignment with millimetre accuracy. Typical characteristics such as closures, embossing and even hairline mould seams are detected by camera and used as alignment marks for this purpose.

### Thus labels end up exactly where they should.

In addition the servos ensure a specific, reproducible rotating cam for each individual container shape for clean and crease free labelling. The complex mechanical replacement of the individual cam segments is not necessary.

### Brand and program changes are accomplished in next to no time!

The same applies to the addition of new equipment variants.

The servos have lifetime lubricated bearings and no gears making them practically wear-free.

This makes their use in HEUFT labellers extremely economical.

ENLIGHTENMENT



### Wet glue labelling units

Tidy application.

### Self-adhesive labelling units

Simply off the roll.

### Wrap-around labelling units

Controllable rotation.

All the labellers of the **HEUFT TORNADO II** series can be equipped with several compact, electrically coupled wet glue stations e.g. for body, collar or neck labelling. The containers are guided past them after they have been transferred to the carousel and fixed by the centring elements.

At the same time the integrated glue segments are covered with an exactly adjustable quantity of glue so that each individual one picks up precisely one label whilst passing.

A gripper cylinder then pulls it off and presses it gently with the glued side against the precisely aligned container. A sponge ensures a homogeneous application.

Platforms which have their own gears rotate the containers so that the wet glue labels are always applied tidily and brushed on without creases. The optionally available Automatic Magazine Feed (AMF) ensures that their supply does not run out too quickly and prevents production stops.

Self-adhesive stations which can be integrated into the **HEUFT TORNADO II** labelling machines easily apply self-adhesive labels with a perfect and close fit.

The containers enter the labeller if the container stop which stops the production flow in the case of a malfunction is unlocked. The infeed worm ensures that the gap between them is correct in the course of this before they are taken over by the infeed starwheel and transferred to the machine carousel.

This is exactly where the self-adhesive labels are applied. The roll with the labels is placed in the labelling unit for this. Thus they can be peeled off at the dispensing plate and applied to the passing containers using special pads. They are firmly clamped for this – in fact in the centre between the rotating platform and the centring bell. Therefore nothing can slip and the labels remain stuck exactly where they belong.

Special units can be integrated into the **HEUFT TORNADO II** machines easily and flexibly for wrap-around labelling – with individually controllable nozzles which apply fine spots of glue in the right quantity and exactly to the containers fixed in platforms by means of centring bells.

A servo-controlled belt drive rotates the containers harmoniously at a speed which can be specifically regulated for different formats so that the labels can wrap themselves around them completely and precisely. The glue spots which have been applied pull the labels out of the magazine. At the same time a special nozzle applies a thin line of glue to the end of the label for the final gluing so that the overlap can be stuck precisely practically without an offset and brushed on carefully.

A closed hot glue system keeps glue consumption low and prevents contamination. This reduces maintenance costs and increases operational reliability during the accurate application of wrap-around labels.

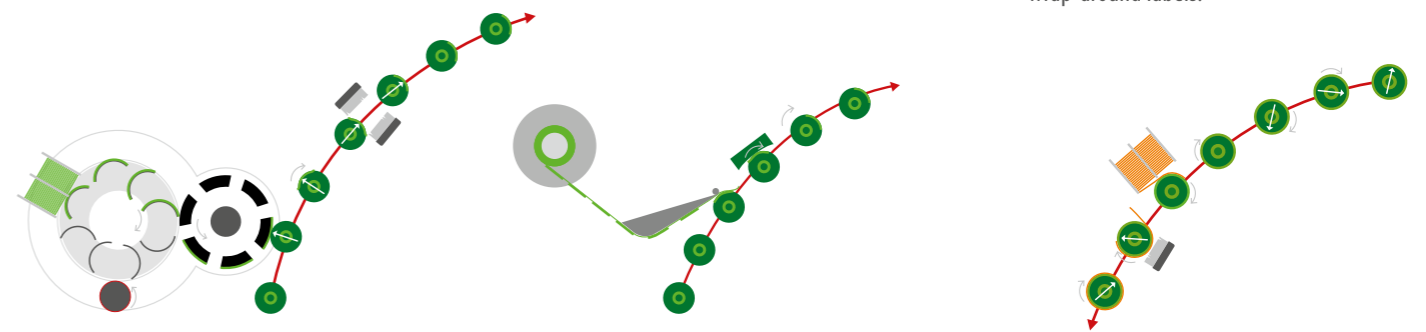



---

## GENTLE & EFFICIENT

Powering, conveying and regulating -  
transporting food and packaging quickly, carefully  
and efficiently along the line.

---

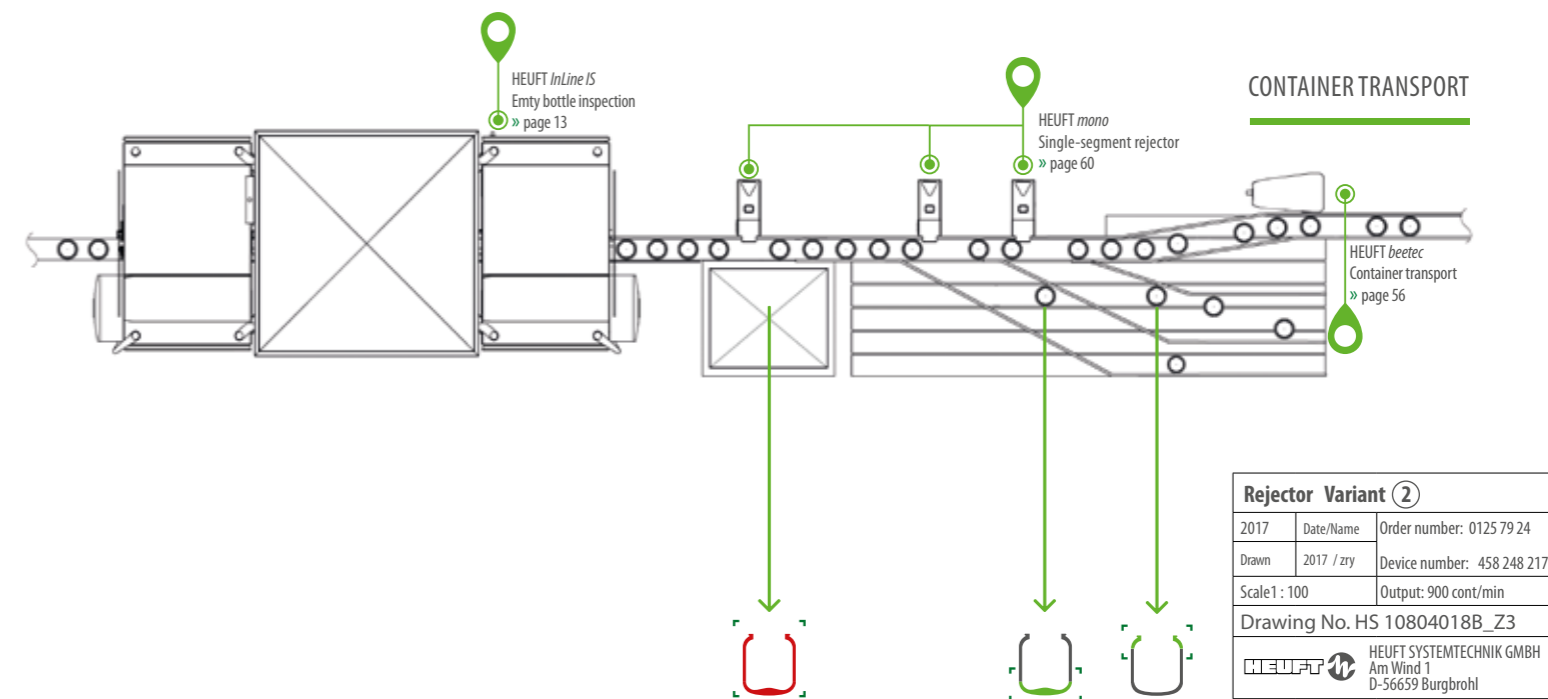
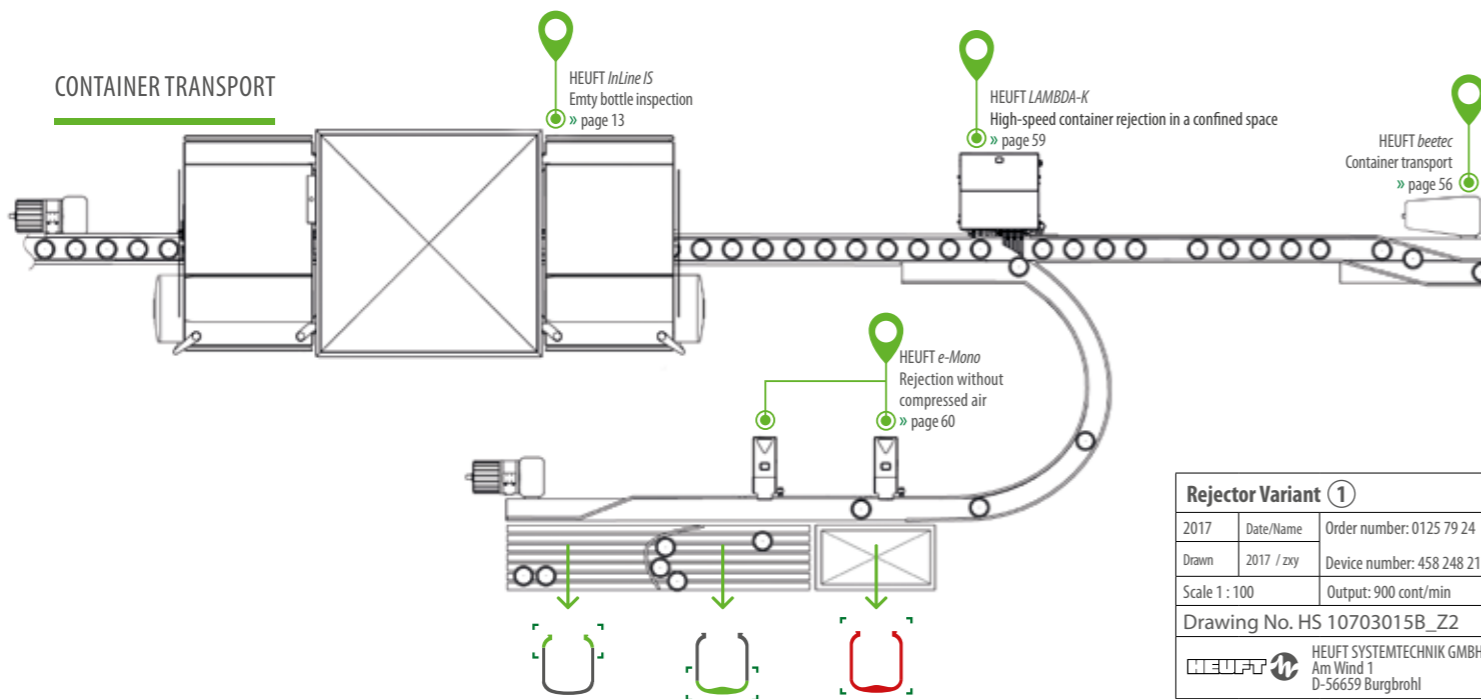

# Our container transport solutions

From conveyor drive to fault rejection.

# Everything flowing smoothly and everything in order!

## No impact pressure and no gaps. Full line efficiency.

Continuous, careful and without pressure: this is what really matters regarding the container flow along your filling and packaging line. After all, the master machines should be continuously supplied, jams prevented and all the products transported fast, safely, smoothly and quietly. You will achieve a harmonious, efficient container flow without interference or impact pressure, even in the high-speed section and in a confined space, with drives, conveyors and conveyor control systems from HEUFT. This protects the quality of the product and the packaging and at the same time increases the efficiency and productivity of the complete line.

### Efficient drive

Energy-saving motors with high efficiency for dynamically driven conveyors.

### Gentle transport

Tailor-made single and multi-lane conveyors.

### Intelligent control system

Proactive conveyor control system for a harmonious container transport without gaps or impact pressure.

### A high degree of flexibility

Specific solutions for the most varied requirements regarding line optimisation.

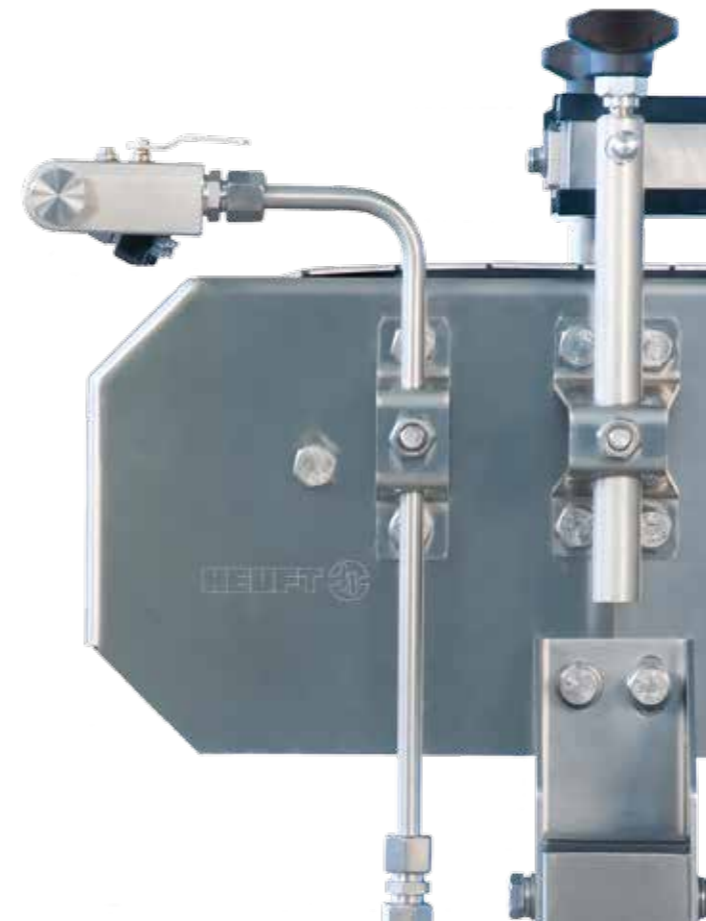

From single-lane to multi-lane transport, from a primary rejection to a fault-specific secondary removal: you can achieve a smooth and efficient product and container flow in a small area with drives, conveyors, conveyor control systems, rejection systems, buffer tables, individually adapted layouts and unique complete solutions from HEUFT!

## Space-saving, flexible and individual

Detailed line analyses, intensive advice and exact planning by competent HEUFT experts create compact solutions which will even fully meet your specific requirements! Products without faults are thus transported carefully through the line so that they remain without faults. Faulty ones are removed specifically and reliably – either by means of a primary rejection directly from the main flow and a subsequent fault-specific secondary removal ① or little by little ② at various positions after the inspector.



## HEUFT conveyor

Powerful conveyors for a safe container transport.

### Optimal conveying

Fast, safe and gentle transport of empty and full food containers on one or several lanes.

### Problem-free integration

Customised adaptation to individual space available and requirements due to a flexible combination of a variety of standard modules and curve radii.

### Construction optimised for maintenance and cleaning

Robust components, adjustments without tools, no "dirty corners" and hardly any contact surfaces for germs.

### Comprehensive advice and planning

Full HEUFT expertise from situation analysis to the specific implementation of individual transport solutions and sustainably optimised line layouts.



**HIGH-SPEED  
CONTAINER  
TRANSPORT**



Discover more

## HEUFT beetec

Highly dynamic and energy-efficient conveyor drive.

### High efficiency and no frictional losses

Up to 88% efficiency and up to 30% less power consumption than conventional drives due to the direct conversion of the energy used into precisely controlled movement and a sustainable power factor correction.

### Long life cycle

Practically no wearing parts or oil changes due to sealed lifetime lubrication - minimum maintenance requirements.

### Hygienic, compact casing

No fans, no cooling fins, protected against dust and water jets as well as minimum noise emission.

### Versatile use

Highly effective real-time drive of single-lane and up to nine-lane multi-chain conveyors.



## HEUFT synchron TXI

Conveyor control system for a harmoniously regulated, efficient container flow.

### Increased efficiency

Smooth, zero-pressure gap closing - proactive prevention of jams, blockages and line stoppages.

### Continuous supply

Single-lane blocking of master machines for maximum efficiency.

### Harmonious mass transport

Careful control of multi-lane conveyors, pressureless regulation of the buffer areas and reliable container distribution.

### Stress-free flow

No glass defects caused by hard collisions and impact pressure, less scuffing and considerably reduced noise.



Smooth gap closing



No jams

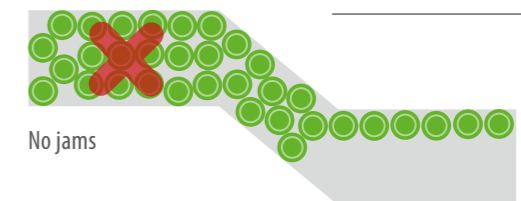

Discover more

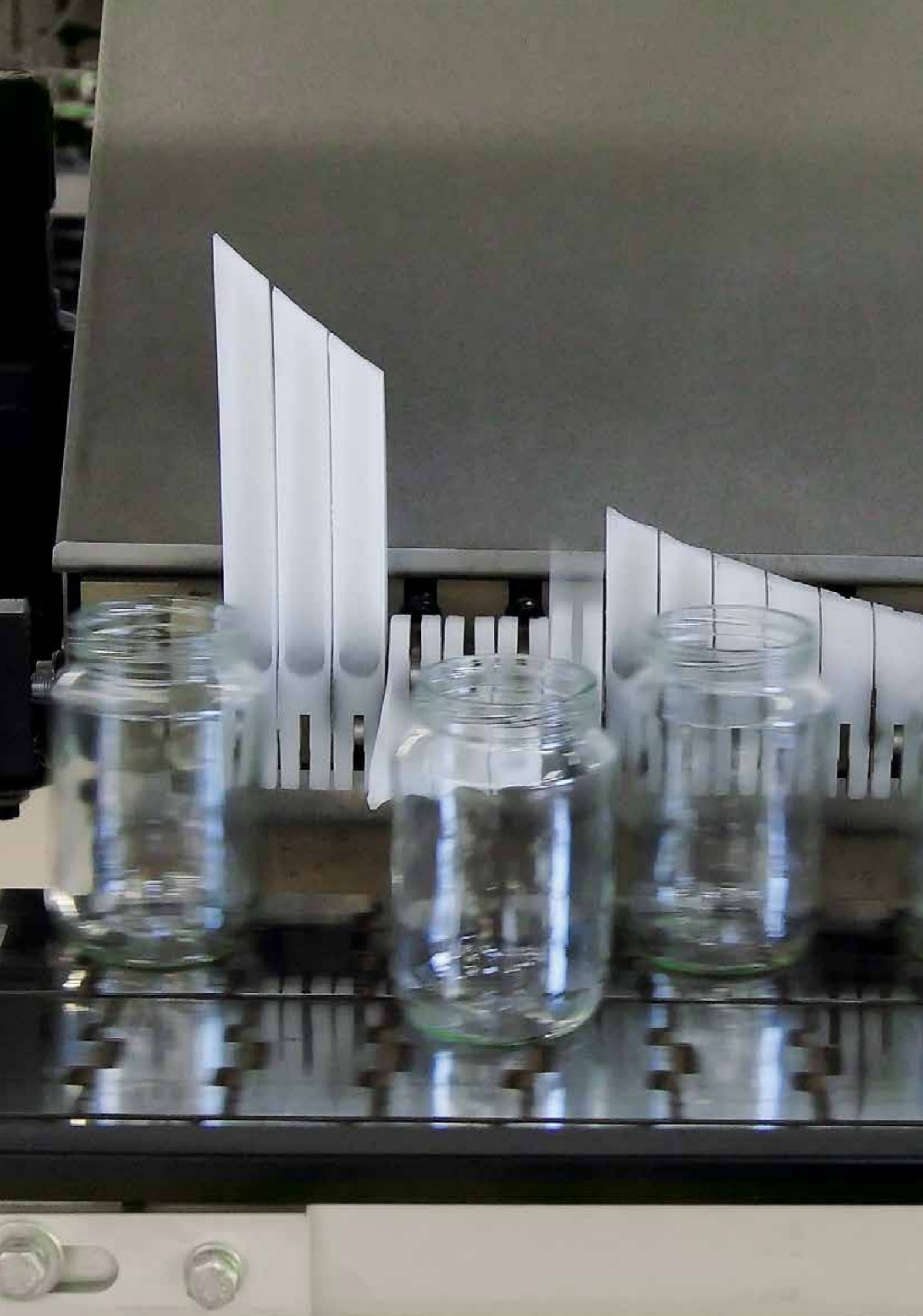

## HEUFT *LAMBDA-K*

Upright high-speed container rejection in a confined space.

### Slim alternative to conventional rejectors with bulky rejection tables

New, particularly compact complete system comprising special conveyor mechanics, intelligent conveyor control system and modified HEUFT *DELTA-K* multi-segment rejector.

### Safe rejection without falling over

Careful upright rejection of faulty or non-brand food packaging due to special segment curve for minimum container resistance.

### Compact conveyor instead of bulky buffer table

Gentle diversion of faulty containers onto a space-saving single lane rejection conveyor.

### Trouble-free changeovers and fast brand changes

Simple adjustment and precise vertical and horizontal settings with a digital display.

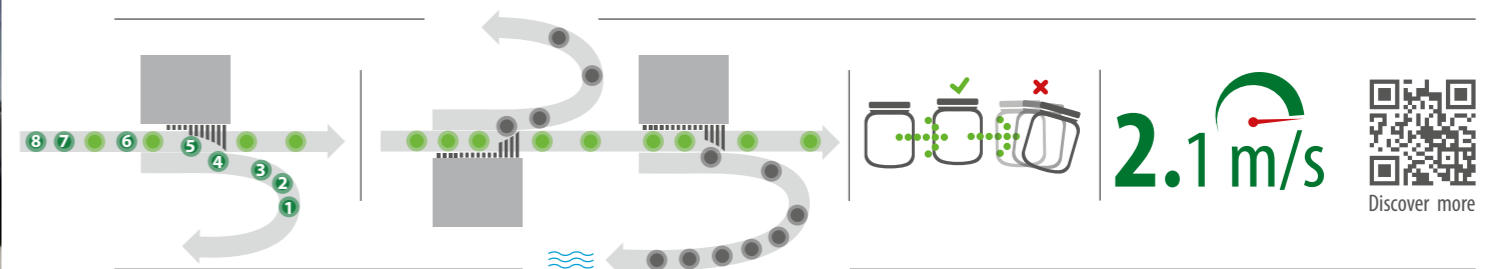

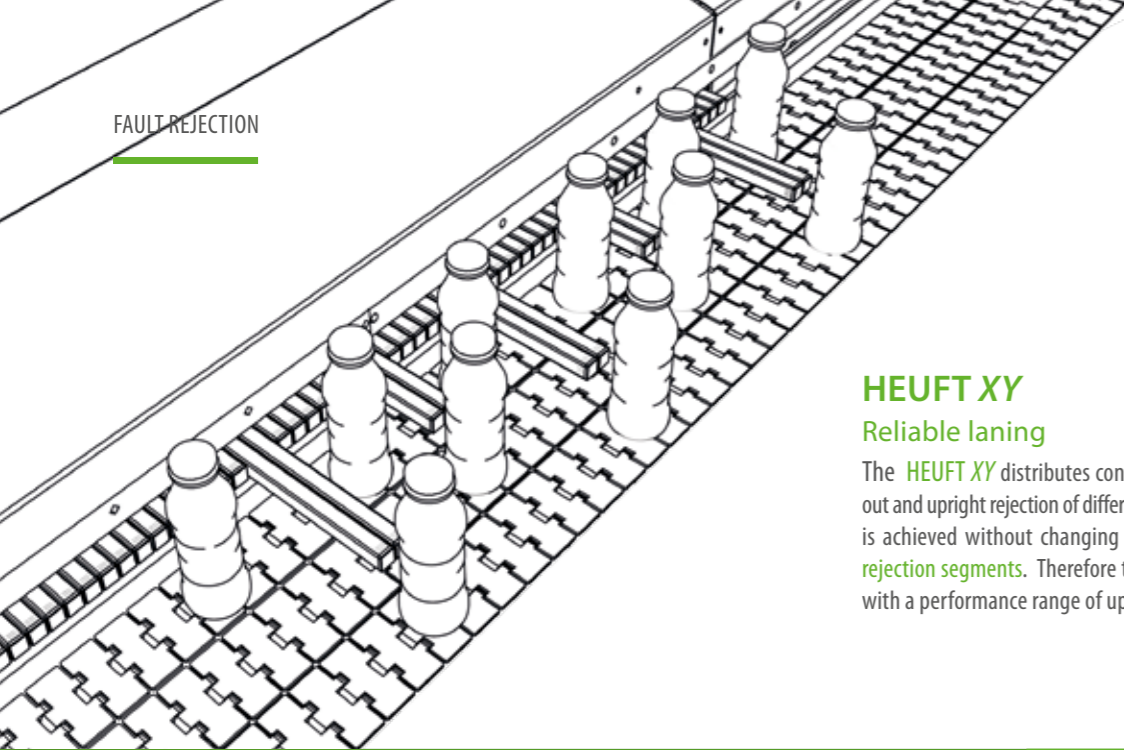

**HEUFT XY**

**Reliable laning**

The **HEUFT XY** distributes containers onto up to four lanes. The sorting out and upright rejection of different shapes of empty and full food packaging is achieved without changing their alignment due to **servo-controlled rejection segments**. Therefore the **HEUFT XY** is ideal for use on food lines with a performance range of up to **1,000 containers** per minute.



**HEUFT pusher**

Compact discharger.

**HEUFT mono**

Careful rejector.

**HEUFT e-Mono**

High-speed rejector without compressed air.

**HEUFT flip**

Smooth rejection.

**HEUFT DELTA-FW**

Dynamic rejection curve.

**HEUFT DELTA-K**

Gentle folding rejector.

The **HEUFT pusher** transports faulty full containers by means of a carefully calculated push to where they belong: in the rubbish. The **single-segment rejection** system works precisely and reliably even on high-speed lines with conveyor speeds of up to 2.5 metres per second and a maximal output of more than **2,100 containers** per minute. The compact **HEUFT pusher** shows its true qualities on canning lines.

Der **HEUFT mono** removes full and empty containers with safety and quality defects reliably. And carefully. A special guide rail on the **single segment rejector** compensates the static friction of the containers for this. Consequently full containers can even be rejected in an upright position without falling over using minimum segment movement. The **HEUFT mono**, a cost-effective all-rounder, is suitable for line outputs of up to **1,200 containers** per minute.

The **HEUFT e-Mono** is ideal for rejecting faulty containers onto a parallel conveyor or directly into a bin. The almost wear-free system does not need expensive, unhygienic compressed air for this and electricity only during the rejection procedure. Its feed force is adapted to the respective weight so that packaging material where the contents vary considerably is nevertheless rejected over the same distance. And that at line outputs of up to **3,000 containers** per minute!

The **HEUFT flip** removes all shapes of empty and full containers smoothly from the packaging line. The unprecedented low mechanical load of the lifting cylinder which sets the rejection segment in motion is due to a cleverly designed joint construction. The compact **HEUFT flip** is ideally suited for the upright rejection of lightweight cylindrical beverage packaging for line outputs of up to **1,000 containers** per minute.

The **HEUFT DELTA-FW** rejects and distributes filled jars and cans upright. Up to sixteen segments form a rejection curve along which they are gently guided. When a good container follows a faulty one only the first container is touched. The system **rejects complete series** reliably with permanently extended segments. And that at line outputs of up to **2,500 containers** per minute.

The **HEUFT DELTA-K** is ideally suited for sorting out empty containers in an upright position, distributing empty and filled containers as well as rejecting complete series. It has up to 16 segments which can be folded out individually so quickly that unsuitable containers can be rejected unproblematically without touching the preceding or subsequent containers. It only rejects that which has to go at line outputs of up to **1,200 containers** per minute.

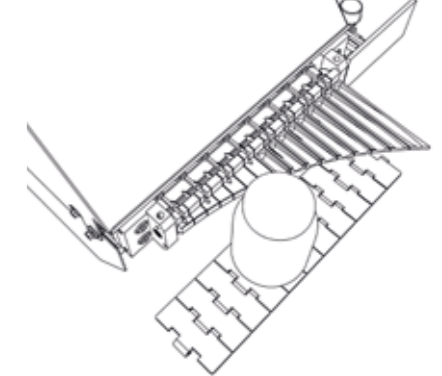
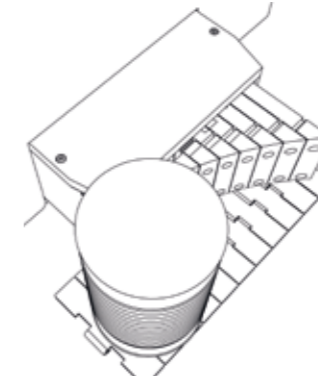
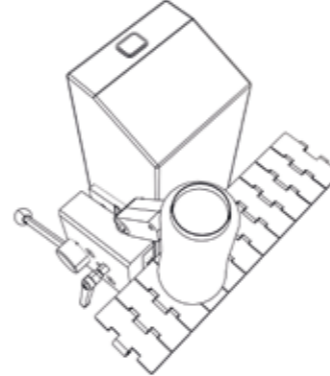
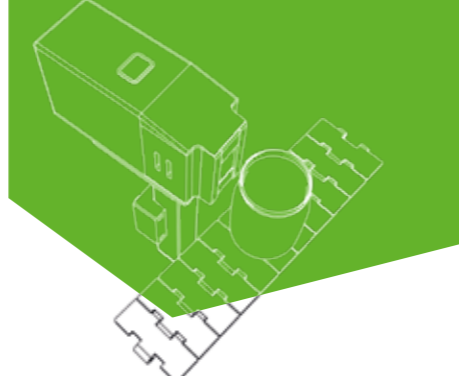
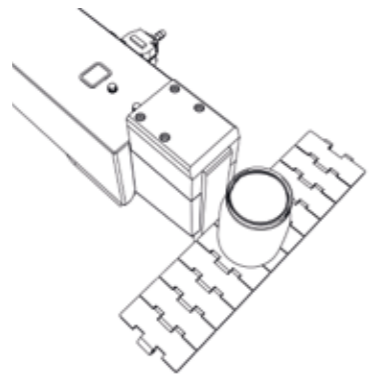
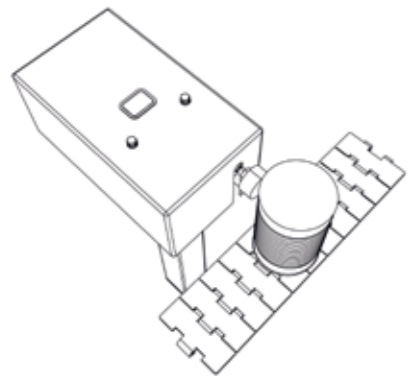



---

## CONTENTS COMPLETE & SAFELY PACKAGED

Checking, measuring and examining – safeguarding the quality and functionality of cardboard boxes, trays and other types of outer packaging in-line.

---



# Our devices for a full case inspection

From checking product completeness to the entire inspection of secondary packaging material.



## For secondary packaging material in top shape. Complete, attractive and functional.

The contents of outer packaging have to be complete. And in addition the secondary packaging material has to be visually appealing as well as easily stackable, transportable and unpackable. HEUFT systems for checking and inspecting the quality of full cases find out whether this is really the case whilst still on the packaging line. Special case rejectors remove distorted, incorrectly sealed or contaminated secondary packaging reliably. In this way only secondary packaging material in top shape reaches the market.

### Everything inside

Reliable examination that the correct number of food products is present in the case.

### Full integrity

Timely detection of safety risks such as foreign objects in a case.

### Full functionality

Sustainable safeguarding of the transportability and unpackability of outer packaging.

### For all cases

Tailor-made solutions for specific requirements.

**COMPLETELY AND PERFECTLY PACKAGED:**  
examining secondary packaging material precisely.





# HEUFT GX

Full case inspection for outer packaging in top shape.

### Extensive quality assurance

Detailed examination of filled cases, cardboard boxes and trays.

### Complete unpackability and transportability

Reliable detection of distorted and incorrectly sealed full cases.

### Fully packaged and the correct height

Reliable examination that the correct number of containers is present in the case and a height profile check for identifying distorted and contaminated compartments as well as faulty containers.

### Specific fault rejection

Consistent removal of incompletely packaged, faulty and non-transportable full cases from the production flow.



# HEUFT logic

Compact full case check for secondary packaging material with complete contents.

### Continuous packaging quality

Reliable examination to check that all the containers are present in cases, cardboard boxes and trays using optical and electromagnetic procedures.

### Precise detection

Reliable identification of incompletely filled full cases due to total coverage of up to eight compartment rows and columns.

### Targeted sorting out of faulty cases

Conveyor stop signal or direct activation of a HEUFT case rejector.

### Flexible adaptation

Height adjustable detection units for different case sizes – up to four pre-programmable brands.



Discover more

up to **120**  
units per minute

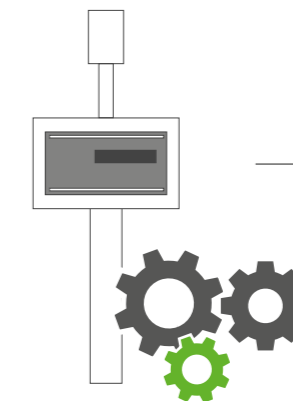
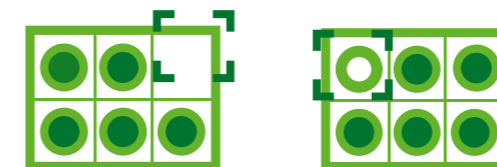
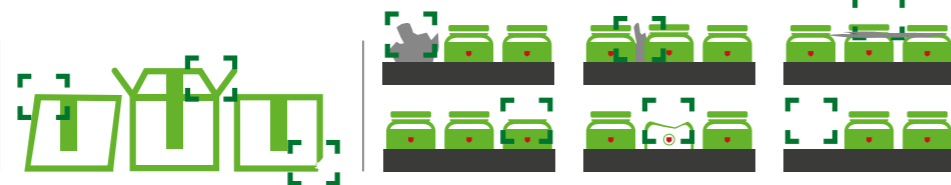

**1,0 m/s**



Discover more



### HEUFT *xcase*

Adaptable rejection push.

### HEUFT *xtray*

Intelligent tray rejection.

### HEUFT *maxi-flip*

Flexible activation.

### HEUFT *maxi-laner*

Compact alternative.

The **HEUFT *xcase*** creates brand purity and quality on a line. Its load-dependent control system, which adapts the force of the rejection push to the weight of each individual case, removes non-brand or faulty outer packaging smoothly from the filling line. Cases of varying weights are therefore each rejected an equal distance.

The **HEUFT *xtray*** removes damaged or faulty full trays from the line. Three rejection fingers assembled on a sledge under the roller conveyor are extended for this purpose. Trays can also be distributed onto several lanes if several of these intelligent case rejectors are lined up next to each other.

The **HEUFT *maxi-flip*** rejects empty, half-full or completely full cases each an equal distance onto parallel conveyor chains. Its rejection segment is activated for a longer time for heavy cases or cardboard boxes than for lighter ones. A complex mechanical changeover for different types of cases is not necessary.

The **HEUFT *maxi-laner*** is even more space saving than the HEUFT *maxi-flip*. The system installed directly above the conveyor is also impressive with a load-dependent control system for the rejection of different cases. Also possible: a reliable distribution onto up to three transport lanes.

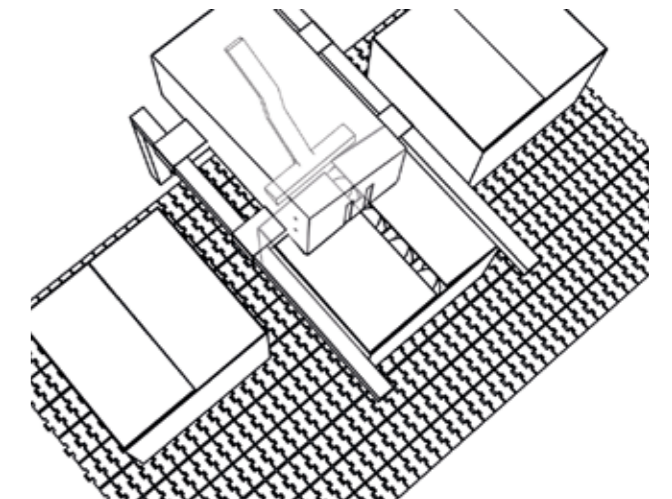
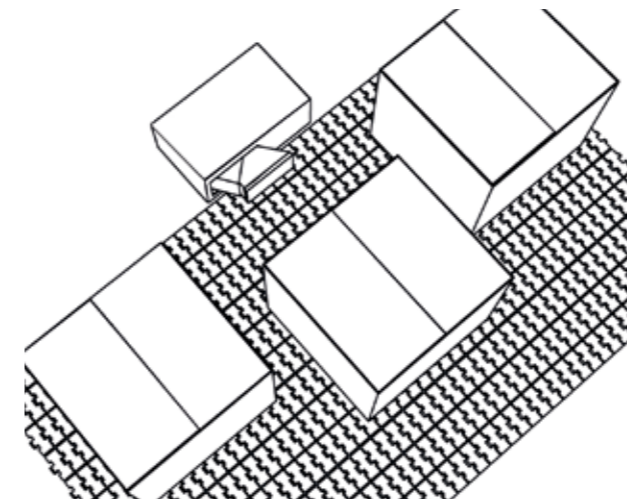
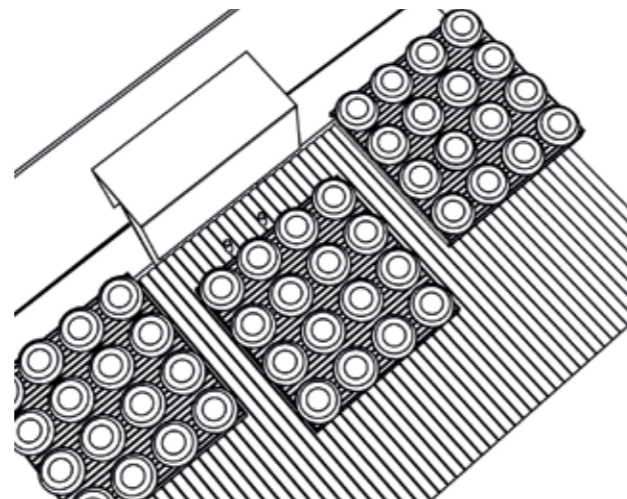
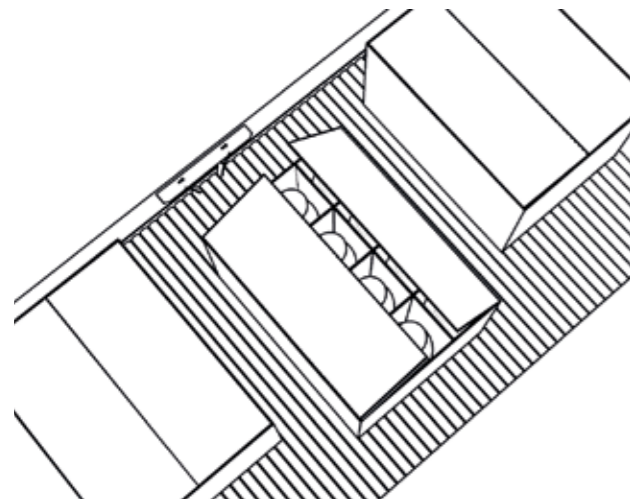

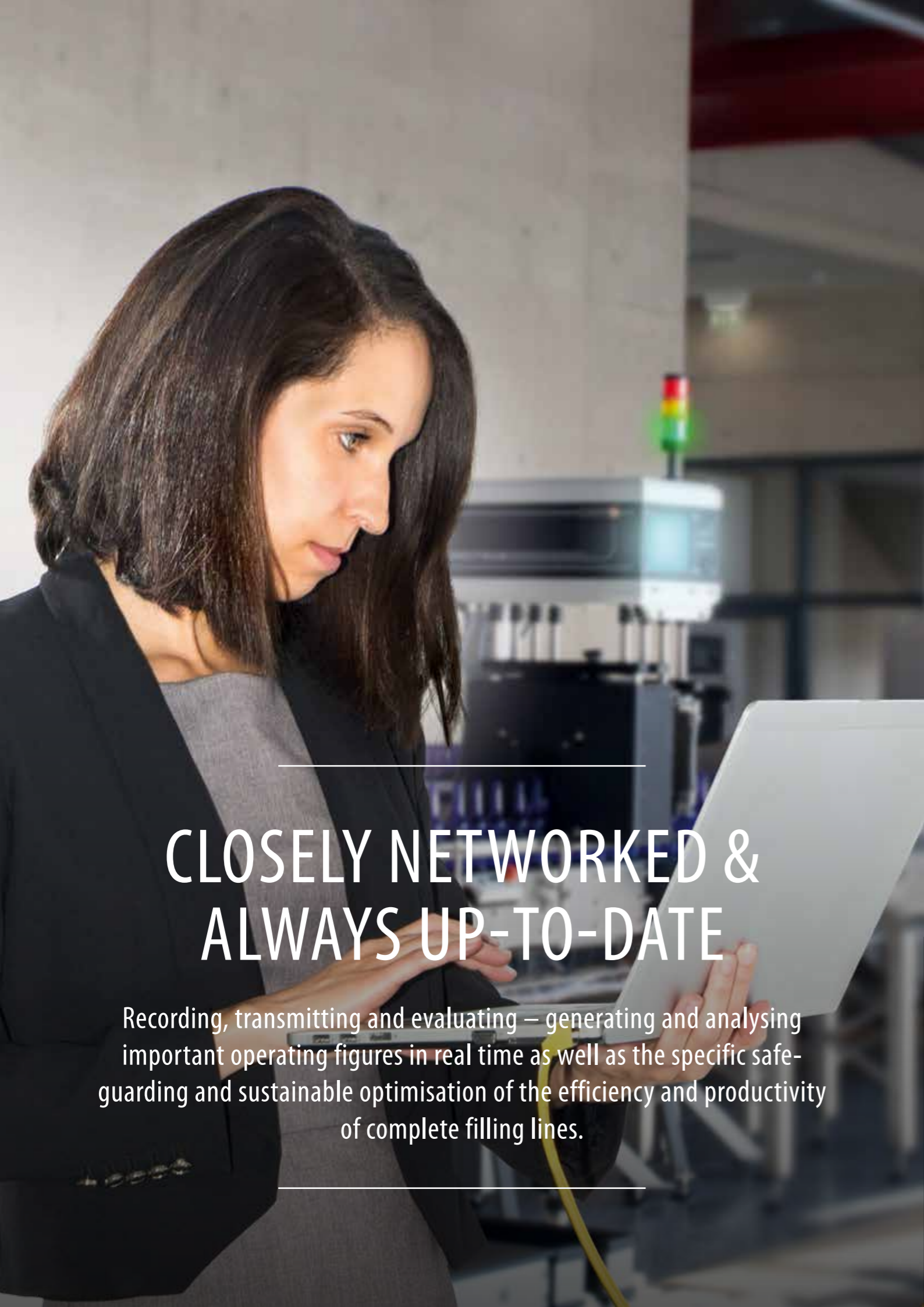

## CLOSELY NETWORKED & ALWAYS UP-TO-DATE

Recording, transmitting and evaluating – generating and analysing important operating figures in real time as well as the specific safeguarding and sustainable optimisation of the efficiency and productivity of complete filling lines.



HEUFT network technologies

## EVERYTHING NETWORKED AND EVERYTHING IN VIEW!

Transferring information, recording operating data, analysing the performance of complete packaging lines and implementing targeted remote maintenance. HEUFT systems are equipped with future-proof network interfaces so that this all works in real time.

**Open, standard and cross-platform protocols generate maximum efficiency and overview.**

All the devices and machines on the line speak the same language and form a network into which office computers can also be integrated without a problem.

Operating and production data, shift records as well as productivity, fault and HACCP limit value analyses are not only available at the HEUFT systems themselves but also everywhere in the network at the same time.

**Interference, safety risks, quality problems and efficiency losses are therefore identified immediately.**

A firewall protected direct connection to the HEUFT *TeleService* makes competent remote maintenance possible all around the clock in order to rectify these at an early stage.

ENLIGHTENMENT



# HEUFT PROFILER family

Production data acquisition (PDA) and line analysis in real time.



### Constant performance analysis

Continuous recording, sustainable backing up and targeted evaluation of production and quality-related data of HEUFT systems / all the networked machines of a packaging line.

### More production quality and more productivity

Early exposure of error sources, weak points and interference for preventive maintenance.

### Precise computing and clear display

Automatic calculation, table and graphic preparation as well as the long-term archiving of important operating figures.

### Different versions for various requirements

Tailor-made, customer-specific tools from a slim software solution for the essentials to an extensive server-based complete line analysis.



HEUFT STRATEGY II server for HEUFT PROFILER and HEUFT PROFILER advanced



HEUFT PROFILER elemental

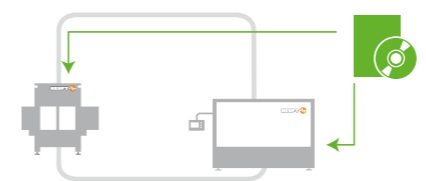
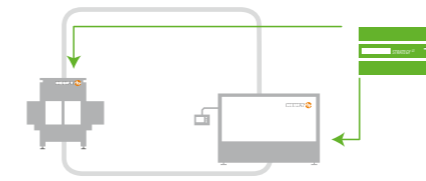
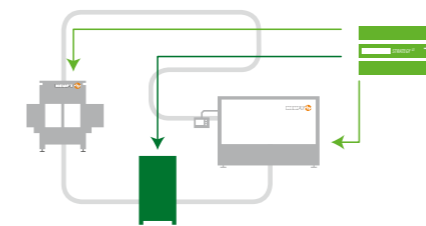

Extension

Upgrade

### HEUFT PROFILER advanced

The complete package for an extensive line analysis – server-based IT tool for HEUFT and non HEUFT devices

### HEUFT PROFILER

The PDA solution with added value – server-based IT tool for HEUFT devices

### HEUFT PROFILER elemental

Software solution for HEUFT devices – the PDA system for the essentials



## HEUFT RECIPER

Networked brand and recipe management.

**More product quality and more output**  
Server-based brand and recipe management in real time.

**Automatic transfer of recipes and equipment features**

Live distribution of all relevant data and parameters to networked HEUFT systems for optimal quality assurance.

**Central brand changeovers**

Direct connection to overall manufacturing execution systems (MES) for easy initiation of program changes and real-time transmission of changed container and equipment characteristics to each HEUFT device in the network.

**Easy new commissioning and modifications**

Uncomplicated addition of new and fast adaptations to existing recipes and equipment features.



HEUFT RECIPER

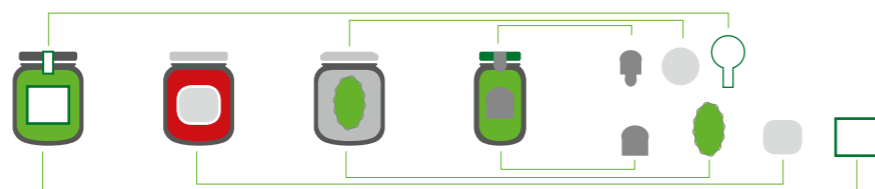

Discover more



## HEUFT picCollect

Automatic transmission and storage of detection pictures.

**Specific production monitoring and sustainable archiving**

Direct transmission and long-term backing up of the camera pictures and X-ray images of all the inspected or all the rejected products for continuously documenting the detection performance of the HEUFT systems.

**Obvious marking for a full overview**

Marking the faults recorded in the jpg image files clearly in red.

**Easy integration**

Slim software tool for uncomplicated installation on customer servers and office PCs.

**Permanent availability**

Constant backing up without a time limit.



HEUFT picCollect

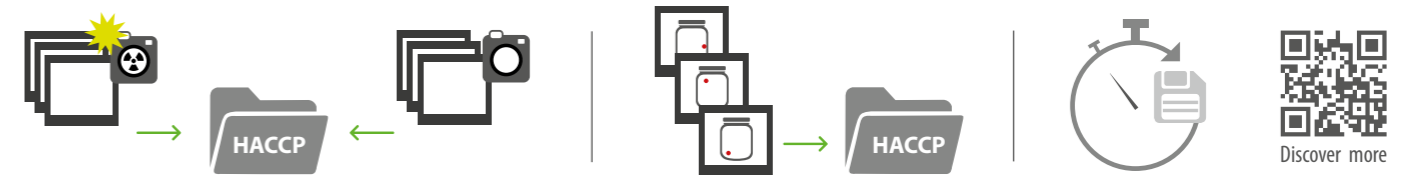

Discover more

## LIFE CYCLE PARTNERSHIP

Those who choose HEUFT receive more than innovative systems which ensure product quality and line efficiency reliably. In HEUFT you have a strong partner at your side providing professional support from the very beginning.

We will bring in our full **expertise** before implementing turnkey solutions. Proactive **support** is provided by us at all times after commissioning. We simply always offer competent **enlightenment** regarding the possibilities and limits of an in-line quality inspection. The result: a reliable partnership which already begins prior to the purchase, extends over the complete life cycle of your HEUFT systems and ensures their full **performance** sustainably.

This minimises the total cost of ownership (TCO) and generates simply more added value, competitiveness and productivity with maximum product quality!



# GLOBAL PLAYER

## GLOBAL SERVICE



- HEUFT LOCATIONS
- PARTNERS
- TIME ZONES
- HEUFT *TeleService* – online and remote diagnosis  
HEUFT *PhoneService* – telephone consultation
- HEUFT *DirectService* – prompt on-site visits
- HEUFT *DeviceSupport* – live overview of the current device status





# HEUFT *TeleService*

Online remote diagnosis and maintenance.



HEUFT *PhoneService*



HEUFT *DirectService*



HEUFT *DeviceSupport*

### Always there for you!

24/7 on-call duty for constant availability in the event of a failure.

### Real remote maintenance in real time

Stable online connection with the nearest local service technician in the HEUFT network for direct access to the device in question – identifying and solving problems promptly.

### Secure tunnel

Firewall and password protected, encrypted VPN IPsec point-to-point connection to any nodes in the HEUFT network.

### Up-to-date hardware and easy handling

New, compact HEUFT *GATEWAY II* server with simplified network configuration for all HEUFT *SPECTRUM* and HEUFT *SPECTRUM II* systems. Straightforward commissioning and easy web-based administration by your own IT team. Display for current status messages. Automatic security updates. Individual solutions with customer-specific network configuration possible.



### Hotline for powerful support.

The HEUFT *PhoneService* is also continuously available. You can contact qualified HEUFT technicians with field experience on the service hotline for our customers seven days a week around the clock. Unlike clueless call centre agents they know exactly what has to be done and support you comprehensively with targeted assistance at inland call rates: the respective problem is diagnosed reliably and solved directly. A prompt on-site visit is arranged immediately if in an exceptional case this should not be possible remotely.

### Fast and effective on-site visits.

You need a service technician at your premises? Then you can count on the fast response times of the HEUFT *DirectService*! With 14 international locations and additional service representatives all over the world the swift arrival of competent experts is always ensured. They deal skilfully with everything necessary for restoring the full availability and operational reliability of your HEUFT systems as quickly as possible.

### Online customer portal for a simply better overview and rapid response.

The HEUFT *DeviceSupport* provides you with an overview of the status and the complete technical documentation for all the installed HEUFT systems including available counter readings, messages and basic documents. In addition the browser-based online portal ensures effective spare parts and service management – with an always up-to-date illustrated spare parts list, virtual shopping basket and service visit calendar. The HEUFT *DeviceSupport* provides safety, transparency and up-to-dateness with user-specific, password protected access rights, customisable desktop, the individual grouping of device lists, user-definable alternative device names and the easy downloading of the latest firmware and software.

# VISIT US IN OUR CUSTOMER CENTER



## SHOWROOM

Experience the complete range of HEUFT solutions in action: our arena with almost 1,000 square metres of exhibition space provides you with the perfect conditions to convince yourself of the superior performance of our inspection and quality assurance systems – even with live tests using products from your own portfolio upon request.

[Visit@heuft.com](mailto:Visit@heuft.com) | +49 2636 56 0



## TRAINING

The right know-how for reliable operation: experienced experts will provide you with all the knowledge you need in order to safeguard the functionality and availability of your HEUFT system sustainably in the HEUFT Training Center – not only theoretically but also directly at the device!

[Training@heuft.com](mailto:Training@heuft.com) | +49 2636 56 2671



## SERVICE

The nerve centre for a proactive customer service: our service control centre coordinates all the services on your premises from online remote maintenance with the HEUFT *TeleService*, the HEUFT *PhoneService* up to HEUFT *DirectService* visits – for a worldwide 24/7 support.

[Technical.Desk@heuft.com](mailto:Technical.Desk@heuft.com) | +49 2636 56 278



## CONFERENCES

From seminar room to auditorium for 199 guests: we are pleased to make our premises containing state-of-the-art multimedia equipment available to customers and partners for meetings and events – including a tour of the premises, specialist lectures and practical presentations!

[Welcome@heuft.com](mailto:Welcome@heuft.com) | +49 2636 56 0



## Technological milestones

1978 1979 1982 1988

The first **HEUFT fill level detection** and the world's first ever **multi-segment rejection** system.

The founding of **HEUFT SYSTEMTECHNIK GMBH**.

The world's first ever device for an **in-line quality inspection** with operator guidance using a **monitor**.

Market launch of the universal **HEUFT SPECTRUM** platform for modular inspection systems.

1991 1998 1999 2001 2002

**HEUFT EBI** – the **first empty bottle inspector** for an efficient **linear operation**.

Market launch of the first **HEUFT TORNADO** labelling machine.

**HEUFT SPECTRUM TX** – a network-compatible platform for modular inspection systems with the **HEUFT PILOT** graphical user interface.

**HEUFT InLine** – an empty container inspection on an area of only one square metre.

**HEUFT squeezer** – a leakage check for filled plastic containers.

In-house developed **HEUFT reflexx** image processing system with specific object detection

**HEUFT PROFILER** – production data acquisition and line analysis.

2003 2005 2010 2011 2013

**HEUFT eXaminer** – unique pulsed X-ray technology for a careful and precise foreign object detection.

**HEUFT FinalView** for an extensive final examination of the container dress.

**HEUFT conveyor** – container transport in accordance with the **HEUFT CleanDesign**.

**HEUFT reflexx<sup>2</sup>** real-time image processing system with specific object detection and classification.

**HEUFT beetec** – a direct drive for container conveyors.

**HEUFT prime** full container check – the first self-explanatory device with the revolutionary audiovisual **HEUFT NaVi** user guidance.

**HEUFT SPECTRUM <sup>XX</sup>** – the latest generation of the universal device platform for a wide variety of inspection tasks with significantly increased performance and automation as well as the self-explanatory audiovisual **HEUFT NaVi** user guidance.

2014 2015 2016 2017 2019

**HEUFT InLine <sup>XX</sup> IXS** – the first empty container inspector with pulsed X-ray technology based on the **HEUFT SPECTRUM <sup>XX</sup>**.

Optimised **HEUFT eXaminer** – technology with X-ray strobes and full-field image converters based on the **HEUFT SPECTRUM <sup>XX</sup>** for even more detection accuracy when detecting foreign objects.

**HEUFT RECIPER** – brand and recipe management.

**HEUFT LAMBDA-K** – a complete system comprising conveyor mechanics, conveyor control system and multi-segment rejector for a careful upright container rejection in a confined space.

**HEUFT ONE** – a new device category for an affordable introduction to a full container inspection on a HEUFT level.

The latest, even more powerful release of the universal, highly automated **HEUFT SPECTRUM <sup>XX</sup>** device platform.

**HEUFT InLine <sup>XX</sup> IS** – the new standard of fully automatic optical empty bottle inspection on a HEUFT level.

**40** years of HEUFT  
40 years of innovation  
40 years of true inspection  
40 years of safe beverages, food and pharmaceuticals  
40 years a reliable partner at your side  
40 years much more...

# GLOBAL PLAYER

● HEUFT subsidiaries    ● HEUFT partners



V2\_2018-1

## HEUFT SYSTEMTECHNIK GMBH

Am Wind 1 · 56659 Burgbrohl · Germany · [heuft.com](http://heuft.com) · [info@heuft.com](mailto:info@heuft.com)